

märklin
H0



Formhauptsignal
70393/70394/70413/70414

| | |
|-------------------------------------|-------|
| Inhaltsverzeichnis | Seite |
| Bestimmungsgemäße Verwendung | 4 |
| Lieferumfang | 4 |
| Sicherheitshinweise | 4 |
| Wichtige Hinweise | 4 |
| Technische Daten | 4 |
| Funktionen | 4 |
| Signal-Einbau | 4 |
| Programmierung mit CS 2 / CS3 | 5 |
| Programmierung mit MS 2 | 5 |
| Betrieb unter mfx | 6 |
| Betriebsart und Adressen einstellen | 28 |
| Aufbau | 39 |
| Aufkleber anbringen | 48 |
| Bohrschablone | 49 |

| | |
|---|------|
| Table of Contents | Page |
| Intended Use of the Product | 7 |
| Contents as Delivered | 7 |
| Safety Notes | 7 |
| Important Notes | 7 |
| Technical Data | 7 |
| Functions | 7 |
| Signal Installation | 7 |
| Programming with the CS 2 / CS3 | 8 |
| Programming with the MS 2 | 8 |
| Operation with mfx | 9 |
| Setting the mode of operation and addresses | 28 |
| Setup | 39 |
| Attach decals | 48 |
| Drilling Template | 49 |

| | |
|--|------|
| Sommaire | Page |
| Utilisation conforme | 10 |
| Livraison | 10 |
| Consignes de sécurité | 10 |
| Consignes importantes | 10 |
| Caractéristiques techniques | 10 |
| Fonctions | 10 |
| Montage du signal | 10 |
| Programmation avec CS 2 / CS3 | 11 |
| Programmation avec MS 2 | 11 |
| Exploitation sous mfx | 12 |
| Définir le mode d'exploitation et les adresses | 28 |
| Montage | 39 |
| Fixez les autocollants | 48 |
| Gabarit de perçage | 49 |

| | |
|----------------------------------|--------|
| Inhoudsopgave | Pagina |
| Beoogd gebruik | 13 |
| Leveringsomvang | 13 |
| Veiligheidsvoorschriften | 13 |
| Belangrijke aanwijzingen | 13 |
| Technische gegevens | 13 |
| Functies | 13 |
| Sein inbouwen | 13 |
| Programmeren met CS 2 / CS3 | 14 |
| Programmeren met MS 2 | 14 |
| Bedrijf met mfx | 15 |
| Bedrijfsmodus en adres instellen | 28 |
| Opbouwen | 39 |
| Bevestig stickers | 48 |
| Boorsjabloon | 49 |

| Índice | Página | Innehållsförteckning | Sidan |
|---|---------------|-------------------------------|--------------|
| Uso previsto | 16 | Användningsområde | 22 |
| Alcance de suministro | 16 | Innehåll | 22 |
| Instrucciones de seguridad | 16 | Säkerhetsföreskrifter | 22 |
| Consejos importantes | 16 | Viktig information | 22 |
| Datos técnicos | 16 | Tekniska data | 22 |
| Funciones | 16 | Funktioner | 22 |
| Montaje de la señal | 16 | Signal-inbyggnad | 23 |
| Programación con CS 2 / CS3 | 17 | Programmering med CS 2 / CS3 | 23 |
| Programación con la MS 2 | 17 | Programmering med MS 2 | 23 |
| Funcionamiento en modo mfx | 18 | Körning med mfx | 24 |
| Configuración de modo de funcionamiento y direcciones | 28 | Ställ in driftstyp och adress | 28 |
| Montaje | 39 | Montering | 39 |
| Allega decalcomanie | 48 | Bifoga dekaler | 48 |
| Plantilla | 49 | Borrschablon | 49 |

| Elenco del contenido | Página | Indholdsfortegnelse | Side |
|---|---------------|-------------------------------|-------------|
| Impiego commisurato alla destinazione | 19 | Hensigtsmæssig anvendelse | 25 |
| Corredo di forniture | 19 | Leveringsomfang | 25 |
| Avvertenze di sicurezza | 19 | Sikkerhedsvejledning | 25 |
| Avvertenze importanti | 19 | Vigtig information | 25 |
| Dati tecnici | 19 | Tekniske data | 25 |
| Funzioni | 19 | Funktioner | 25 |
| Montaggio del segnale | 20 | Signalindbygning | 26 |
| Programmazione con CS 2 / CS3 | 20 | Programmering med CS 2 / CS3 | 26 |
| Programmazione con MS 2 | 20 | Programmering med MS 2 | 26 |
| Esercizio sotto mfx | 21 | Drift med mfx | 27 |
| Impostate tipo di funzionamento e indirizzi | 28 | Indstil driftsart og adresser | 28 |
| Montaggio | 39 | Forsamling | 39 |
| Coloque las calcomanías | 48 | Vedhæft decals | 48 |
| Maschera di Foratura | 49 | Boreskabelon | 49 |

Bestimmungsgemäße Verwendung

- Das Signal ist zum Einbau in H0 Digital-Modellbahn-Anlagen.
- Das Signal darf für den Analogbetrieb nur mit Stellpult 72760 verwendet werden.
- Darf nur in geschlossenen Räumen verwendet werden.

Lieferumfang

- 1 Signal
- 1 Kabel mit Stecker 2 polig, rot und braun
- 1 Kabel mit Stecker 3 polig, rot und rot
- 1 Kabel mit Stecker 3 polig, violett, rot-braun, rot-grün,
- 2 Haltewinkel zur Unterflurmontage
- 1 Halteplatte C-Gleis
- 4 Isolierungen (rot) C-Gleis (1Spritzling)
- 2 Mittelleiter-Isolierung (grau) K-Gleis
- 1 Mittelleiter-Anschluss K-Gleis
- 1 Schiebepbilder zur Kennzeichnung
- Einbauanleitung mit Schablone zur Unterflurmontage
- Garantieurkunde

Für die Unterflurmontage zusätzlich benötigtes Werkzeug: Schraubendreher, 4x Senkkopfschrauben Ø 2,5mm x (Länge abhängig von der Einbautiefe), Bohrer Ø 16mm und 2mm.

Sicherheitshinweise

- **ACHTUNG!** Funktionsbedingte scharfe Kanten und Spitzen.
- Verkabelungs- und Montagearbeiten nur im spannungslosen Zustand ausführen. Bei Nichtbeachtung kann es zu gefährlichen Körperströmen und damit zu Verletzungen führen.
- **Signal nur mit der zulässigen Spannung** (siehe technische Daten) **betreiben**.

Wichtige Hinweise

- Die Bedienungsanleitung ist Bestandteil des Produktes und muss deshalb aufbewahrt sowie bei Weitergabe des Produktes mitgegeben werden.
- Für Reparaturen wenden Sie sich bitte an Ihren Märklin-Fachhändler.
- Entsorgung: www.maerklin.com/en/imprint.html

Technische Daten

- Belastung ≤ 100 mA
- Belastung Gleis Ausgang max. 2 A
- Spannungsfestigkeit max. 40 V

Funktionen

- Multiprotokollfähig: fx (MM), mfx und DCC
- Einstellen der Betriebsart mittels DIP-Schalter
- Einstellbare Adressen mit DIP-Schalter:
 - 1 – 256 fx (MM) (Control Unit 6021)
 - 1 – 320 fx (MM) (Central Station 6021x/Mobile Station 60653)
 - 1 – 511 (DCC)
- Programmierbare Adressen über CV
 - 1 – 2.040 DCC
- Änderungen der Eigenschaften über CV
- Stromversorgung über Digitalstromkreis

Signal-Einbau

Vor dem eigentlichen Einbau muss das Signal programmiert werden.

Folgende Arbeitsschritte dürfen nur im spannungslosen Zustand ausgeführt werden:

Einstellung der Adresse und Betriebsart durch den DIP-Schalter:

- Einstellen der Betriebsart mit DIP-Schalter 10
Schalter 10 off = fx (MM) / mfx
Schalter 10 on = DCC
- fx (MM)/DCC einstellen der Adresse mit DIP-Schalter (Tabelle ab Seite 28)

! Beachten Sie:

- Einstellungen mit dem DIP-Schalter immer spannungslos vornehmen. Das Signal erkennt erst mit dem Einschalten der Spannung die aktuellen Schalterstellungen.
- **Zum Schalten der Signale 70413 und 70414** werden grundsätzlich 2 Adressen (Tastenpaare) benötigt. Die 2. Adresse wird automatisch als Folgeadresse vergeben. Diese Folgeadresse **ist nicht frei wählbar**.

Programmierung mit CS 2 / CS 3

fx (MM)

Die CV Programmierung muss am Programmiergleis erfolgen. Es darf **immer nur ein Signal** am Programmiergleis angeschlossen werden.

Folgende CV können bei fx (MM) verändert werden: CV 39, 40, 41 und 42. Bei den CV 41 und 42 muss bei fx (MM) der Wert durch 4 geteilt werden, denn es sind nur Werte 0-80 zulässig z.B. $255/4 = 64$ (gerundet).

Während des Programmiervorganges blinkt die Signallampe, abweichend davon wird während des Programmierens mit der Central Station das Signal geschaltet. Nach Abschluss des Programmiervorganges wird das Signal auf „Fahrt“ gestellt.

Die Vorgehensweise beim Programmieren mit der Control Unit 6021 finden Sie auf www.maerklin.de -> Service -> Technische Informationen.

Die Programmierung mit anderen Geräten, entnehmen Sie bitte der Bedienungsanleitung des jeweiligen Steuergerätes.

DCC

Die CV Programmierung muss am Programmiergleis erfolgen. Es darf **immer nur ein Signal** am Programmiergleis angeschlossen werden. Während der Datenübertragung blinkt zur Kontrolle die Signallampe.

Die Programmierung mit anderen Geräten, entnehmen Sie bitte der Bedienungsanleitung des jeweiligen Steuergerätes.

Programmierung mit MS 2

Zur Programmierung der Signale mit der Mobile Station 2 muss eine neue Lokomotive manuell unter MM2 oder DCC angelegt werden.

Beachten Sie bitte, dass dann das zu programmierende Signal über die Codierschalter auch auf MM2 oder DCC und auf die selbe Adresse wie die Lokomotive eingestellt wurde. Diese neu angelegte Lokomotive wird nur für die Programmierung der Signale benötigt. Gehen Sie dazu im Menü der MS 2 auf „Lok konfigurieren“ und anschließend auf „CV programmieren“. Während des CV-programmierens dürfen keine anderen Lokomotiven, Signale oder Weichendecoder angeschlossen sein.

CV für fx (MM) und DCC

Unter fx (MM) kann die Adresse nur mit dem DIP-Schalter eingestellt werden. Werte in Klammern sind die Werkseinstellungen.

| CV | Bedeutung | Werte | |
|------|---|-------------|---|
| 1 | Adresse 1 – 255 | 1-255 (1) | nur DCC |
| 9 | Adressen 256 – 2040 | 0-7 (0) | nur DCC |
| PoM* | Langsame Bewegung | 0 (0) | |
| | Mittelschnelle Bewegung | 1 | |
| | Schnelle Bewegung | 2 | |
| | Mittelschnelle Bewegung mit Nachwippen | 3 | |
| | Schnelle Bewegung mit Nachwippen | 4 | |
| | Mittelschnelle Bewegung mit Nachwippen Flügel 1 | 5 | nur bei 70411 / 70412 / 70413 / 70414 |
| | Mittelschnelle Bewegung mit Nachwippen Flügel 2 | 6 | nur bei 70411 / 70412 / 70413 / 70414 |
| 40 | Beleuchtung | 0 – 15 (15) | 0 Licht aus Dimmen 0-15, wobei 15 = 100% Helligkeit entspricht |
| PoM* | | | |
| 41 | Mittelstellung Flügel 1 | 0 – 255 | Einstellung der Mittelposition für den Flügel aller Signale |
| PoM* | | | |
| 42 | Mittelstellung Flügel 2 | 0 – 255 | nur bei 70411 / 70412 / 70413 / 70414 Einstellung der Mittelposition für den 2. Flügel |
| PoM* | | | |



*PoM programmieren kann, sofern es vom Steuergerät unterstützt wird, am Hauptleis erfolgen.

Einstellen und errechnen der Adressen größer 255 (DCC):

Z.B. Adresse 1044 -> $1044:256=4,078125$. Der Wert vor dem Komma (4) ist in CV 9 einzutragen. Der Wert nach dem Komma (0,078125) wird mit 256 multipliziert $0,078125 \times 256=20$. Der errechnete Wert 20 muss in CV 1 eingetragen werden.

Betrieb unter mfx

Die mfx-Anmeldung kann unter MM oder DCC erfolgen. Entscheidend ist die über den Dip-Schalter 10 eingestellte Betriebsart.

Die mfx-Anmeldung wird mit der CS2 60213/60214/60215 in der Magnetartikelkonfiguration über  >  und mit der CS3 60216/60226 in der Magnetartikelkonfiguration über  > „mfx-Artikel suchen“ angestoßen.

Hinweis zur mfx-Anmeldung mit der CS2:

Auswahlmöglichkeit „Magnetartikel automatisch zuweisen“ unter „Setup“ >  > „Gleis“.

Ist dort das Häkchen gesetzt erfolgt die mfx-Anmeldung auf die ersten freien Adressen in der CS2. Ist das Häkchen nicht gesetzt, erfolgt die mfx-Anmeldung auf die tatsächlich am Decoder programmierten Adressen.

Intended Use of the Product

- This signal is for installation on HO digital model railroad layouts.
- This signal may only be used for analog operation with the 72760 control box.
- Use only in enclosed areas.

Contents as Delivered

- 1 Signal
- 1 Cable with plug, 2-conductor, red and brown
- 1 Cable with plug, 3-conductor, red and red
- 1 Cable with plug, 3-conductor, violet, red-brown, red-green
- 2 Mounting brackets for below-baseboard installation
- 1 Mounting for C Track
- 4 Insulator sleeves (red) for C track (1 sprue)
- 2 Center conductor insulators (gray) for K Track
- 1 Center conductor connector for K Track
- 1 Set of decals for identification
- Installation instructions with a template for below-baseboard installation
- Warranty card

Additional tools required for below-baseboard installation: screwdriver, 4 each countersunk screws Ø 2.5 mm x (length dependent on the installation depth), drills Ø 16 mm and 2 mm.

Safety Notes

- **IMPORTANT!** The product has sharp edges and points due to the way it works.
- Do wiring and installation work only when there is no voltage present. Failure to adhere to this may cause life-threatening current and injury.

- **This signal is to be operated only with the permissible voltage** (see technical data).

Important Notes

- The operating instructions are a component part of the product and must therefore be kept in a safe place as well as for transfer of the product to third parties.
- Please see your authorized Märklin specialty dealer for repairs.
- Disposing of the product: www.maerklin.com/en/imprint.html

Technical Data

- Load ≤ 100 milliamps
- Load at the track output max. 2 amps
- Electrical strength max. 40 volts

Functions

- Capable of multi-protocols: fx (MM), mfx, and DCC
- Mode of operation set by means of DIP switches
- Addresses can be set by means of DIP switches:
 - 1 – 256 fx (MM) (Control Unit 6021)
 - 1 – 320 fx (MM) (Central Station 6021x/Mobile Station 60653)
 - 1 – 511 (DCC)
- Programmable addresses by means of CVs +1-2,040 DCC
- Characteristics can be changed by means of CVs
- Power supplied by means of the digital current circuit

Signal Installation

The signal must be programmed before actually installing it.

The following work steps may be done only when there is no voltage present:

Setting the address and the mode of operation with the DIP switches:

- Setting the mode of operation with DIP Switch 10
Switch 10 off = fx (MM) / mfx
Switch 10 on = DCC
- fx (MM)/DCC Setting the address with DIP switches (See table starting on Page 28)

! Please note:

- Always do settings with the DIP switches when there is no voltage present. The signal does not recognize the current switch settings until the voltage is turned on.
- Basically, 2 addresses (pairs of buttons) are required to **switch the 70413 and 70414 signals**. The second address is assigned automatically as a sequential address. This sequential address **cannot be selected at will**.

Programming with the CS 2 / CS 3

fx (MM)

The CV programming must be done on the programming track. **Only one signal** may be connected to the programming track **at a time**.

The following CVs can be changed in fx (MM): CV 39, 40, 41, and 42. With CVs 41 and 42 the value must be divided by 4 in fx (MM), because only the values 0-80 are allowed, for example: $255/4 = 64$ (rounded).

During the programming procedure, the signal light will blink. During programming with the Central Station, by contrast the signal is switched. After the end of the programming procedure, the signal is set at "Go".

The procedure for programming with the 6021 Control Unit

can be found at www.maerklin.de -> Service -> Technische Informationen.

Please see the operating instructions for the control devices in question for programming with other devices.

DCC

CV programming must be done on the programming track. **Only one signal** may be connected to the programming track **at a time**. The light on the signal will blink as a check during the data transmission.

Please see the operating instructions for the control devices in question for programming with other devices.

Programming with the MS 2

A new locomotive must be set up manually under MM2 or DCC in order to program signals with the Mobile Station 2.

Please note that the signal to be programmed is then also set by means of the coding switches to MM2 or DCC and to the same address as the locomotive. This newly set up locomotive is only required for the programming of signals. To do this go in the MS 2 menu to „Configure Locomotive“ and then to „Program CV“.

No other locomotive, signals, or turnout decoders may be connected while the CV(s) are being programmed.

CV for fx (MM) and DCC

With fx (MM) the address can be set only with the DIP switches. The values in parentheses are factory default settings.

| CV | Meaning | Values | |
|----|----------------------|-----------|----------|
| 1 | Address 1 - 255 | 1-255 (1) | only DCC |
| 9 | Addresses 256 - 2040 | 0-7 (0) | only DCC |

| CV | Meaning | Values | |
|------|---|-------------|---|
| 39 | Slow movement | 0 (0) | |
| PoM* | Medium fast movement | 1 | |
| | Fast movement | 2 | |
| | Medium fast movement with bouncing | 3 | |
| | Fast movement with bouncing | 4 | |
| | Medium fast movement with bouncing of Arm 1 | 5 | only with 70411 / 70412 / 70413 / 70414 |
| | Medium fast movement with bouncing of Arm 2 | 6 | only with 70411 / 70412 / 70413 / 70414 |
| 40 | Meaning Lighting | 0 - 15 (15) | 0 light off Dimming 0-15, whereby 15 = 100% brightness |
| PoM* | | | |
| 41 | Center setting for Arm 1 | 0 - 255 | Setting of the middle position for the arm on all signals |
| PoM* | | | |
| 42 | Center setting for Arm 2 | 0 - 255 | Only with 70411 / 70412 / 70413 / 70414 Setting of the middle position for the 2nd arm |
| PoM* | | | |



*PoM programming can be done on the main track as long as it is supported by the control device.

Setting and Calculating Addresses Greater than 255 (DCC):

Example: Address 1044 -> 1044 : 256 = 4.078125. The value before the decimal point (4) is entered in CV 9. The value after the decimal point (0.078125) is multiplied by 256 $0.078125 \times 256 = 20$. The calculated value of 20 must be entered in CV 1.

Operation with mfx

mfx registration can be done with MM or DCC. The mode of operation that has been set by means of Dip Switch 10 is critical.

The mfx registration is initiated with the 60213/60214/60215 CS2 in  >  and with the 60216/60226 CS3 in the solenoid item configuration by means of  > "search for mfx item".

Note about mfx registration with the CS2:

Selection possibility „Automatically assign solenoid item“ at „Setup“ >  > „Track“.

If the check mark there is checked, the mfx registration is done at the first open address in the CS2. If the check mark is not checked, the mfx registration is done at the address actually programmed on the decoder.

Utilisation conforme

- Le signal est conçu pour être monté sur des circuits ferroviaires miniatures numériques H0.
- Le signal ne doit être utilisé en mode analogue qu'avec un pupitre de commande 72760.
- Ne doit être utilisé que dans une pièce fermée.

Livraison

1 signal

1 câble avec prise bipolaire, rouge et marron

1 câble avec prise tripolaire, rouge et rouge

1 câble avec prise tripolaire, violet, rouge-brun, rouge-vert

2 équerres de fixation pour montage souterrain

1 plaque de maintien voie C

4 isolations (rouge) voie C (1 pièce moulée par injection)

2 isolations pour conducteur central (gris) voie K

1 connecteur pour conducteur central voie K

1 image à coulisser pour la signalisation

Instructions de montage avec schéma pour montage souterrain

Certificat de garantie

Outils supplémentaires requis pour le montage souterrain :

Tournevis, 4x vis à tête fraisée Ø 2,5mm x (la longueur dépendant de la profondeur de montage), perceuse Ø 16mm et 2mm.

Consignes de sécurité

- **ATTENTION !** Le matériel comporte des bords coupants et des pointes.
- Effectuer les travaux de câblage et de montage uniquement lorsque le circuit est hors tension. Dans le cas contraire, vous risquez de vous électrocuter et de vous blesser.

- **Utiliser le signal uniquement avec la tension autorisée** (cf. caractéristiques techniques).

Consignes importantes

- Le mode d'emploi fait partie intégrante du produit. Vous devez donc la conserver et la transmettre avec le produit.
- Pour les travaux de réparation, veuillez vous adresser à votre revendeur Märklin.
- Élimination : www.maerklin.com/en/imprint.html

Caractéristiques techniques

- Charge ≤ 100 mA
- Charge sortie voie max. 2 A
- Rigidité diélectrique max. 40 V

Fonctions

- Multiprotocole : fx (MM), mfx et DCC
- Réglage du mode de fonctionnement au moyen d'un interrupteur DIP
- Adresses réglables au moyen de l'interrupteur DIP:
 - 1 – 256 fx (MM) (Control Unit 6021)
 - 1 – 320 fx (MM) (Central Station 6021x/Mobile Station 60653)
 - 1 – 511 (DCC)
- Adresses programmables via CV
 - 1 – 2 040 DCC
- Modification des propriétés via CV
- Alimentation électrique via circuit électrique numérique

Montage du signal

Avant le montage à proprement parler, vous devez programmer le signal.

Vous réaliserez les étapes suivantes uniquement lorsque le circuit est hors tension :

Réglage de l'adresse et du mode de fonctionnement via l'interrupteur DIP :

- Réglage du mode de fonctionnement au moyen d'un interrupteur DIP 10
Interrupteur 10 off = fx (MM) / mfx
Interrupteur 10 on = DCC
- fx (MM)/DCC Réglage de l'adresse via l'interrupteur DIP (tableau à partir de la page 28)

! Attention :

- Effectuer les réglages via l'interrupteur DIP uniquement hors tension. Le signal reconnaît les positions du commutateur dès l'activation de la tension.
- **Pour commuter les signaux réf. 70413 et 70414**, deux adresses (paires de touches) sont en principe nécessaires. La 2^{de} adresse automatiquement attribuée est l'adresse consécutive. Cette adresse consécutive **ne peut pas être choisie librement**.

Programmation avec CS 2 / CS 3

fx (MM)

La programmation CV doit se faire au niveau de la voie de programmation. Vous ne devez brancher **qu'un seul signal** sur la voie de programmation.

Vous pouvez modifier les CV suivant dans fx (MM) : CV 39, 40, 41 et 42. Pour les CV 41 et 42 vous devez diviser la valeur de fx (MM) par 4 car seules des valeurs de 0-80 sont autorisées, par ex. $255/4 = 64$ (arrondie).

Pendant la programmation, la lampe du signal clignote, et, indépendamment de cela, le signal est couplé à la Central Station pendant la programmation. Une fois la procédure de programmation terminée, le signal est mis sur « circulation ».

Vous trouverez la procédure de programmation au moyen de la Control Unit 6021 à la page www.maerklin.de -> Service -> Technische Informationen (www.marklin.fr/fr/produits/outils/base_donnees_produits.html)

Pour la programmation avec d'autres appareils, veuillez consulter les modes d'emploi des pupitres de commande correspondant.

DCC

La programmation CV doit se faire au niveau de la voie de programmation. ne devez brancher **qu'un seul signal** sur la voie de programmation. Pendant la transmission des données, la lanterne du signal clignote.

Pour la programmation avec d'autres appareils, veuillez consulter les modes d'emploi des pupitres de commande correspondant.

Programmation avec MS 2

La programmation des signaux avec la Mobile Station 2 nécessite la création manuelle d'une nouvelle locomotive sous MM2 ou DCC. Veuillez tenir compte du fait que le signal à programmer aura alors été paramétré via les commutateurs de codage également sur MM2 ou DCC et sur la même adresse que la locomotive. Cette nouvelle locomotive créée est requise uniquement pour la programmation des signaux. A cet effet, allez dans le menu de la MS 2 sur « Configuration loco », puis sur « Programmation CV ». Pendant la programmation des CV, aucune autre locomotive ni

aucun autre signal ou décodeur d'aiguille ne doit être raccordé.

CV pour fx (MM) et DCC

Dans fx (MM), vous pouvez configurer l'adresse uniquement via l'interrupteur DIP. Les valeurs entre parenthèses sont les paramètres d'usine.

| CV | Éclairage | Valeur | |
|------|---|-------------|--|
| 1 | Adresse 1 - 255 | 1-255 (1) | uniquement DCC |
| 9 | Adresses 256 - 2040 | 0-7 (0) | uniquement DCC |
| 39 | Mouvement lent | 0 (0) | |
| PoM* | Mouvement de vitesse moyenne | 1 | |
| | Mouvement rapide | 2 | |
| | Mouvement de vitesse moyenne avec mouvement de ressort | 3 | |
| | Mouvement de vitesse rapide avec mouvement de ressort | 4 | |
| | Mouvement de vitesse moyenne avec mouvement de ressort aile 1 | 5 | uniquement pour 70411 / 70412 / 70413 / 70414 |
| | Mouvement de vitesse moyenne avec mouvement de ressort aile 2 | 6 | uniquement pour 70411 / 70412 / 70413 / 70414 |
| 40 | Éclairage | 0 - 15 (15) | 0 lumière éteinte variateur 0-15, 15 = 100% de luminosité |
| PoM* | | | |
| 41 | Réglage moyen aile 1 | 0 - 255 | Réglage de la position moyenne pour l'aile de tous les signaux |
| PoM* | | | |

| CV | Éclairage | Valeur | |
|------|----------------------|---------|--|
| 42 | Réglage moyen aile 2 | 0 - 255 | uniquement pour 70411 / 70412 / 70413 / 70414 réglage de la position moyenne pour la 2e aile |
| PoM* | | | |

*Vous pouvez effectuer la programmation PoM, si elle est prise en charge par le pupitre de commande, sur la voie principale.



Réglage et calcul des adresses supérieures à 255 (DCC) :

Par ex. adresse 1044 -> $1044:256=4,078125$. Vous devez reporter la valeur avant la virgule (4) dans CV 9. Multipliez la valeur après la virgule (0,078125) par 256 $0,078125 \times 256=20$. Reportez la valeur calculée 20 dans CV 1.

Exploitation sous mfx

L'enregistrement mfx peut se faire sous MM ou DCC.

C'est le mode d'exploitation défini via le commutateur Dip 10 qui importe ici.

Avec la CS2 60213/60214/60215, l'enregistrement mfx est lancé dans la configuration des articles électromagnétiques via  >  et avec la CS3 60216/60226 dans la configuration des articles électromagnétiques via  > „Rechercher articles mfx“.

Remarque concernant la connexion mfx avec la CS2 :

Sélection possible „Affectation automatique d'un article électromagnétique“ sous „Configuration“ >  > „Voie“.

Si cette possibilité est cochée, l'enregistrement mfx se fait sur les premières adresses libres dans la CS2. Si cette possibilité n'est pas cochée, l'enregistrement mfx se fait sur les adresses réellement programmées sur le décodeur.

Beoogd gebruik

- Het sein is bestemd voor het inbouwen in H0-modelbanen.
- Het sein mag in analoogbedrijf alleen in combinatie met het schakelkastje 72760 gebruikt worden.
- Het mag alleen in gesloten ruimtes gebruikt worden.

Leveringsomvang

- 1 Sein
- 1 Kabel met stekker 2-polig rood en bruin
- 1 Kabel met stekker 3-polig rood en rood
- 1 Kabel met stekker 3-polig violet, rood-bruin, rood-groen
- 2 Hoekhouders voor ondervloermontage
- 1 houderplaat voor C-rail
- 4 Isolaties (rood) C-rail (1 gietstuk)
- 2 Middenrail isolaties (grijs) K-rail
- 1 Middenrail aansluiting K-rail
- 1 Transfer voor herkenning
- Inbouw-aanwijzing met sjabloon voor ondervloermontage
- Garantiebewijs

Voor de ondervloermontage zijn daarnaast nog nodig: een schroevendraaier, 4 verzonken schroeven \varnothing 2mm x (lengte afhankelijk van de inbouwdiepte), boor \varnothing 16 mm en 2 mm.

Veiligheidsvoorschriften

- **LET OP!** Heeft vanwege de functionaliteit scherpe kanten en punten.
- Bedrading en montagewerkzaamheden alleen in spanningloze toestand uitvoeren. Als dit niet in acht genomen wordt kunt u gevaarlijke stroomschokken krijgen met de daarmee samenhangende verwondingen.

- **Het sein alleen met de toegelaten spanning** (zie technische gegevens) **gebruiken**.

Belangrijke aanwijzingen

- De gebruiksaanwijzing is een bestandsdeel van het product en dient daarom bewaard en meegegeven worden met het product.
- Voor reparaties kunt u zich tot uw Märklin dealer wenden.
- Verwijdering-aanwijzing: www.maerklin.com/en/imprint.html

Technische gegevens

- Belasting \leq 100 mA
- Belasting railuitgang max. 2 A
- S-pinning max. 40 V

Functies

- Multi-protocol geschikt voor: fx (MM) , mfx en DCC
- Instellen van het bedrijfssysteem met dipschakelaar
- Instelbare adressen met dipschakelaars:
 - 1 – 256 fx (MM) (Control Unit 6021)
 - 1 – 320 fx (MM) (Central Station 6021x/ Mobile Station 60653)
 - 1 – 511 (DCC)
- Programmeerbare adressen via CV
 - 1 – 2040 DCC
- Veranderen van de eigenschappen via CV
- Stroomvoorziening via digitale stroomkring

Sein inbouwen

Voor het inbouwen moet het sein eerst geprogrammeerd worden.

De volgende werkzaamheden mogen alleen in spanningloze toestand worden uitgevoerd:

- Instellen van het adres en het bedrijfssysteem met dipschakelaar:
- Instellen van het bedrijfssysteem met dipschakelaar 10
Schakelaar 10 off = fx (MM) / mfx
Schakelaar 10 on = DCC
- fx (MM) / DCC instellen van het adres met dipschakelaar (tabel zie pagina 28)

! Let op:

- instelling met de dipschakelaar altijd in spanningloze toestand uitvoeren. Het sein herkent de actuele instelling pas na het inschakelen van de spanning.
- **Om de seinen 70413 en 70414** te kunnen schakelen zijn altijd 2 adressen (toetsenparen) nodig. Het 2de adres wordt automatisch als vervolgadres uitgegeven. Die vervolgadres **kan niet vrij gekozen** worden.

Programmeren met CS 2 / CS 3

fx (MM)

De CV programmering moet op het programmeerspoor worden uitgevoerd. Er mag **altijd maar één sein** op het programmeerspoor zijn aangesloten.

De volgende CV's kunnen bij fx (MM) veranderd worden: CV 39, 40, 41 en 42. Bij de CV's 41 en 42 moet bij fx (MM) de waarde door 4 worden gedeeld omdat alleen waarden van 0-80 toelaatbaar zijn, bijv. $255/4 = 64$ (afgerond).

Tijdens het programmeren knippert het licht van het sein, afwijkend daarvan wordt tijdens het programmeren met het Central Station het sein geschakeld. Na het afsluiten van het programmeren wordt het sein in de stand "veilig" gezet.

De werkwijze voor het programmeren met de Control Unit 6021 vindt u op www.maerklin.de -> Service -> Technische Informatie

De wijze van programmering met andere apparaten vindt u in de gebruiksaanwijzing van het desbetreffende apparaat.

DCC

De CV programmering moet op het programmeerspoor worden uitgevoerd. Er mag **altijd maar één sein** op het programmeerspoor zijn aangesloten. Tijdens de overdracht van de gegevens knippert het licht van het sein ter controle.

De wijze van programmering met andere apparaten vindt u in de gebruiksaanwijzing van het desbetreffende apparaat.

Programmeren met MS2

Voor het programmeren van seinen met het Mobile Station 2 moet, onder MM2 of DCC, handmatig een nieuwe locomotief ingevoerd worden.

Let er op dat het te programmeren sein met de codeerschakelaars ook op MM2 of DCC en op hetzelfde adres ingesteld staat als de locomotief. Deze nieuw ingevoerde locomotief wordt alleen gebruikt voor het programmeren van het sein. Ga hiervoor in het menu van het MS2 naar "loc configureren" en aansluitend naar "CV programmeren".

Tijdens het programmeren mogen geen andere locomotieven, seinen of wisseldecoders aangesloten zijn.

CV voor fx (MM) en DCC

Onder fx (MM) kan het adres alleen met de dipschakelaar worden ingesteld. De waarden tussen haakjes zijn de fabrieksinstellingen.

| CV | Omschrijving | Waarde | |
|------|--|-------------|--|
| 1 | Adres 1 - 255 | 1-255 (1) | alleen DCC |
| 9 | Adres 256 - 2040 | 0-7 (0) | alleen DCC |
| 39 | Langzaam bewegen | 0 (0) | |
| PoM* | Middel snel bewegen | 1 | |
| | Snel bewegen | 2 | |
| | Middel snel bewegen met navippen | 3 | |
| | Snel bewegen met navippen | 4 | |
| | Middel snel bewegen met navippen arm 1 | 5 | Alleen bij 70411 / 70412 / 70413 / 70414 |
| | Middel snel bewegen met navippen arm 2 | 6 | Alleen bij 70411 / 70412 / 70413 / 70414 |
| 40 | Verlichting | 0 - 15 (15) | 0=licht uit, dimmen 0-15 waarbij 15 = 100% helderheid |
| PoM* | | | |
| 41 | Middenstand arm 1 | 0 - 255 | Instelling van de middenstand van de arm van alle seinen |
| PoM* | | | |
| 42 | Middenstand arm 2 | 0 - 255 | Alleen bij 70411 / 70412 / 70413 / 70414 Instelling van de middenstand van de 2de arm |
| PoM* | | | |

* PoM programmeren kan, voor zover het besturingsapparaat dit ondersteund, op het hoofdspoor gebeuren.

Instellen en berekenen van de adressen groter dan 255 (DCC):

Bijv. adres 144 -> 1044:256= 4,078125. De waarde voor de komma (4) moet in CV 9 ingevoerd worden. De waarde na de komma (0,078125) wordt met 256 vermenigvuldigd, 078125x256=20. De berekende waarde (20) wordt in CV 1 ingevoerd.

Bedrijf met mfx

De mfx aanmelding kan zowel onder MM als onder DCC gebeuren.

Bepalend daarvoor is het ingestelde bedrijfstype met dip-schakelaar 10.

De mfx aanmelding wordt met het CS2 60213/60214/60215 in de magneetartikel configuratie via  >  en met het CS3 60216/60226 in de magneetartikelen configuratie via  > "mfx-artikel zoeken" gestart.

Opmerking t.a.v. mfx aanmelding met het CS2

Keuzemogelijkheid "Magneetartikelen automatisch toewijzen" onder "Setup" >  "Rail".

Als daar het vinkje gezet is, vindt de mfx-aanmelding plaats op de eerste vrije adressen in het CS2. Is het vinkje niet gezet, dan vindt de mfx-aanmelding op het werkelijke, op de decoder geprogrammeerde adres plaats.

Uso previsto

- La señal ha sido concebida para su montaje en maquetas de trenes digitales H0.
- Está permitido utilizar la señal para funcionamiento analógico solo con el panel de mando 72760.
- Está permitido su uso solo en recintos cerrados.

Alcance de suministro

1 señal

1 cable con conector de 2 polos, rojo y marrón

1 cable con conector de 3 polos, rojo y rojo

1 cable con conector de 3 polos, violeta, rojo-marrón, rojo-verde

2 escuadras soporte para montaje bajo el suelo

1 placa soporte para vía C

4 aislamientos (rojo) para vía C (1 pieza inyectada)

2 aislamientos de conductor central (gris) para vía K

1 toma de conductor central para vía K

1 juego de indicadores deslizantes para identificación

Instrucciones de montaje con plantilla para montaje bajo el suelo.

Documento de garantía

Herramientas también necesarias para el montaje bajo el suelo: destornillador, 4 tornillos de cabeza avellanada Ø 2,5mm x (longitud en función de la profundidad de montaje), brocas de Ø 16 mm y 2 mm.

Instrucciones de seguridad

- **¡ATENCIÓN!** Por su funcionalidad, incluye aristas cortantes y puntas.
- Realizar los trabajos de cableado y montaje siempre sin tensión eléctrica. En caso contrario, se pueden producir peligrosas corrientes a través del cuerpo y, por tanto, lesiones físicas.

- **Asegurar que la señal funcione solo a la tensión admisible** (ver Datos técnicos).

Consejos importantes

- Las instrucciones de empleo forman parte integrante del producto y, por este motivo, deben conservarse y entregarse al nuevo comprador en el caso de venta o transmisión del producto.
- Para las reparaciones, por favor diríjase a su distribuidor Märklin.
- Eliminación: www.maerklin.com/en/imprint.html

Datos técnicos

Carga admisible ≤ 100 mA

Carga de salida de vía máx. 2 A

Rigidez dieléctrica máx. 40 V

Funciones

- Apta para multiprotocolo: fx (MM), mfx y DCC
- Selección del modo de funcionamiento con microint. DIP
- Direcciones configurables con microint. DIP:
 - 1 – 256 fx (MM) (Control Unit 6021)
 - 1 – 320 fx (MM) (Central Station 6021x/Mobile Station 60653)
 - 1 – 511 (DCC)
- Direcciones programables vía CV
 - 1 – 2.040 DCC
- Modificaciones de las propiedades vía CV
- Alimentación eléctrica vía circuito digital

Montaje de la señal

Antes del montaje propiamente dicho, debe programarse la señal.

Está permitido ejecutar las siguientes operaciones únicamente sin tensión eléctrica:

Configuración de la dirección en el modo de funcionamiento mediante el microint. DIP:

- Configuración del modo de funcionamiento con microint. DIP 10
Microinterruptor 10 retirado = fx (MM) / mfx
Microinterruptor 10 colocado = DCC
- fx (MM)/DCC Configuración de la dirección con microint. DIP (Tabla a partir de página 28)

!Tenga presente lo siguiente:

- Realizar la configuración con el microint. DIP siempre sin tensión eléctrica. La señal no identifica las posiciones actuales del microinterruptor hasta que se activa la tensión.
- Por norma, **para conmutar las señales 70413 y 70414** se necesitan 2 direcciones (pares de teclas). La 2ª dirección se asigna automáticamente, siendo ésta la dirección siguiente. Esta dirección siguiente **no se puede seleccionar libremente.**

Programación con CS 2 / CS 3

fx (MM)

La programación de variables CV debe realizarse en la vía de programación. Está permitido conectar a la vía de programación **siempre solo una señal.**

En el modo fx (MM) pueden modificarse las siguientes CVs: CV 39, 40, 41 y 42. En las CV 41 y 42, en el modo fx (MM), el valor debe dividirse por 4 ya que están permitidos los valores 0-80, p. ej., $255/4 = 64$ (redondeado).

Durante la operación de programación, la lámpara de la señal destella y, a diferencia de ello, durante la operación de programación, la lámpara de la señal destella mientras que,

por el contrario, durante la programación con la Central Station la señal se conmuta. Una vez finalizada la programación, se cambia la señal a «Marcha».

Encontrará el procedimiento en la programación con la Control Unit 6021 en www.maerklin.de -> Service -> Technische Informationen.

Para realizar la programación con otras unidades de control, consulte su manual de instrucciones de empleo.

DCC

La programación de las CVs debe realizarse en la vía de programación. Está permitido conectar a la vía de programación **siempre solo una señal.** Durante la transmisión de datos, a modo de comprobación, luce el farol de la señal.

Para realizar la programación con otras unidades de control, consulte el manual de instrucciones de empleo de la unidad en cuestión.

Programación con la MS 2

Para programar las señales con la Mobile Station 2 se debe crear una locomotora nueva en MM2 o DCC.

En tal caso, asegúrese de que la señal a programar haya sido configurada, mediante los interruptores codificadores, también a MM2 o DCC y a la misma dirección que la locomotora. Esta locomotora nueva creada se necesita solo para la programación de las señales. Para ello, vaya a "Configurar locomotora" en el menú de la MS 2 " y seleccione "Programar CVs".

Durante la programación de las CVs no debe estar conectada ninguna otra locomotora, señal o decoder de desvío.

CV para fx (MM) y DCC

En fx (MM), es posible configurar la dirección solo con el micro-interruptor DIP. Los valores entre paréntesis representan la configuración de fábrica.

| CV | Significado | Valores | |
|------|---|-------------|--|
| 1 | Dirección 1 - 255 | 1-255 (1) | solo DCC |
| 9 | Direcciones 256 - 2040 | 0-7 (0) | solo DCC |
| PoM* | 39 Movimiento lento | 0 (0) | |
| | Movimiento semirrápido | 1 | |
| | Movimiento semirrápido con rebasculación | 2 | |
| | Movimiento semirrápido con rebasculación | 3 | |
| | Movimiento rápido con rebasculación | 4 | |
| | Movimiento semirrápido con rebasculación de brazo 1 | 5 | solo con 70411 / 70412 / 70413 / 70414 |
| | Movimiento semirrápido con rebasculación de brazo 2 | 6 | solo con 70411 / 70412 / 70413 / 70414 |
| PoM* | 40 Alumbrado | 0 - 15 (15) | 0 Luz apagada Regular intensidad a 0-15, en donde 15 equivale a brillo 100% |
| PoM* | 41 Posición central brazo 1 | 0 - 255 | Configuración de la posición central para el brazo de todas las señales |

| CV | Significado | Valores | |
|------|-----------------------------|---------|---|
| PoM* | 42 Posición central brazo 2 | 0 - 255 | solo en 70411 / 70412 / 70413 / 70414 Configuración de la posición central para el segundo brazo |



*La programación en marcha PoM, siempre que así lo soporte la unidad de control, puede realizarse en la vía principal.

Configuración y cálculo de las direcciones mayores que 255 (DCC):

P. ej., dirección 1044 -> $1044:256=4,078125$. El valor antes de la coma (4) debe registrarse en la variable CV 9. El valor decimal (0.078125) se multiplica por 256 $0,078125 \times 256=20$. El valor calculado, 20, debe registrarse en la variable CV 1.

Funcionamiento en modo mfx

El inicio de sesión en mfx se puede realizar en modo MM o DCC. El modo de funcionamiento se selecciona con el microinterruptor DIP 10.

El inicio de sesión en modo mfx se inicia con la CS2 60213/60214/60215 en la configuración de artículos magnéticos a través de  >  y con la CS3 60216/60226 en la configuración de artículos magnéticos a través de  > "Buscar artículos mfx".

Nota sobre el inicio de sesión en mfx con la CS2:

Posibilidad de selección de „Asignar automáticamente artículos magnéticos” en „Setup (configuración)” >  > „Vía”.

Si en estas funciones se ha activado la marca de verificación, el inicio de sesión en modo mfx se realiza en las primeras direcciones libres de la CS2. Si no está activada la marca de verificación, el inicio de sesión en mfx se realiza en las direcciones realmente programadas en el decoder.

Impiego commisurato alla destinazione

- Tale segnale è da installare in impianti di ferrovia in miniatura H0 digitali.
- Per il funzionamento analogico tale segnale deve venire impiegato solo con il quadro di comando 72760.
- Deve venire utilizzato soltanto in ambienti chiusi.

Corredo di fornitura

1 segnale

1 cavetto con spina a 2 poli, rosso e marrone

1 cavetto con spina a 3 poli, rosso e rosso

1 cavetto con spina a 3 poli, violetto, rosso-marrone, rosso-verde

2 squadrette di supporto per montaggio sotto plancia

1 piastra di supporto per binario C

4 isolamenti (rossi) per binario C (1 pressofusione)

2 isolamenti per conduttore centrale (grigio) per binario K

1 connessione per conduttore centrale per binario K

1 figure trasferibili per identificazione

Istruzioni di montaggio con mascherina per montaggio sotto plancia

Certificato di garanzia

Per il montaggio sotto plancia, attrezzi aggiuntivi necessari: cacciavite, 4x viti a testa svasata Ø 2,5mm x (lunghezza dipendente dalla profondità di montaggio), punte da trapano Ø 16mm e 2mm.

Avvertenze di sicurezza

- **ATTENZIONE!** Bordi e spigoli acuminati per necessità funzionali.
- Eseguire i lavori di cablaggio e montaggio soltanto nelle condizioni di assenza di tensione. In caso di mancato rispetto, questo può portare a pericolose correnti corporee e pertanto a ferimenti.

- **Si faccia funzionare il segnale solamente con la tensione ammissibile** (si vedano i dati tecnici).

Avvertenze importanti

- Le istruzioni di impiego costituiscono parte integrante del prodotto e devono pertanto venire conservate con cura nonché consegnate insieme in caso di cessione a terzi del prodotto.
- Per riparazioni Vi preghiamo di rivolgerVi al Vostro rivenditore specialista Märklin.
- Smaltimento: www.maerklin.com/en/imprint.html

Dati tecnici

- Carico ≤ 100 mA
- Carico all'uscita per il binario max. 2 A
- Resistenza alla tensione max. 40 V

Funzioni

- Adatto a protocolli multipli: fx (MM), mfx e DCC
- Impostazione del tipo di esercizio a mezzo commutatore DIP
- Indirizzi impostabili con commutatore DIP:
 - 1 – 256 fx (MM) (Control Unit 6021)
 - 1 – 320 fx (MM) (Central Station 6021x/Mobile Station 60653)
 - 1 – 511 (DCC)
- Indirizzi programmabili tramite le CV
 - 1 – 2.040 DCC
- Variazioni delle caratteristiche tramite le CV
- Alimentazione di corrente tramite circuito di corrente digitale
- Illuminazione del segnale disattivabile oppure attivabile

Montaggio del segnale

Prima del vero e proprio montaggio il segnale deve venire programmato.

I seguenti passi del lavoro devono venire eseguiti soltanto nelle condizioni esenti da tensione:

Impostazione dell'indirizzo e del tipo di funzionamento mediante il commutatore DIP:

- Impostazione del tipo di funzionamento con commutatore DIP 10
Commutatore 10 off = fx (MM) / mfx
Commutatore 10 on = DCC
- fx (MM)/DCC impostazione dell'indirizzo con commutatore DIP (Tabella da pagina 28)

! Prestate attenzione:

- Intraprendere le impostazioni con il commutatore DIP-Schalter sempre senza tensione. Il segnale riconosce le disposizioni attuali del commutatore solo con l'accensione della tensione.
- **Per la commutazione dei segnali 70413 e 70414** vengono richiesti sostanzialmente 2 indirizzi (coppie di tasti). Il 2° indirizzo viene assegnato automaticamente come indirizzo successivo. Questo indirizzo successivo **non è selezionabile liberamente.**

Programmazione con CS 2 / CS 3

fx (MM)

La programmazione delle CV deve avvenire sul binario di programmazione. Al binario di programmazione deve venire collegato **sempre soltanto un segnale.**

Le seguenti CV possono venire modificate nel caso di fx (MM): CV 39, 40, 41 e 42. Nelle CV 41 e 42 in caso di fx (MM) il valore

deve venire diviso per 4, poiché sono consentiti valori 0-80, ad es. $255/4 = 64$ (arrotondato).

Durante la procedura di programmazione la luce del segnale lampeggia, in modo differente da ciò durante la programmazione con la Central Station il segnale è acceso. Dopo la conclusione del procedimento di programmazione il segnale viene disposto su „via libera“.

Il procedimento durante la programmazione con la Control Unit 6021 potete trovarlo su www.maerklin.de -> Service -> Technische Informationen.

La programmazione con altri apparati siete pregati di desumerla dalle istruzioni di azionamento del rispettivo apparato di controllo.

DCC

La programmazione delle CV deve avvenire sul binario di programmazione. Al binario di programmazione deve venire collegato **sempre soltanto un segnale.** Durante il trasferimento dei dati per controllo lampeggia il fanale sul segnale.

La programmazione con altri apparati siete pregati di desumerla dalle istruzioni di azionamento del rispettivo apparato di controllo.

Programmazione con MS 2

Per la programmazione dei segnali con la Mobile Station 2 deve venire definita manualmente una nuova locomotiva sotto MM2 oppure DCC. Si prega di prestare attenzione al fatto che poi anche il segnale da programmare mediante il commutatore di codifica sia stato impostato su MM2 oppure DCC, sullo stesso indirizzo come tale locomotiva. Questa locomotiva definita come nuova è necessaria soltanto per la programmazione del segnale. A tale scopo andate nel Menù della MS 2 su „Configurazione

loco” e successivamente su „Programmazione CV“. Durante tale programmazione delle CV non deve essere collegata alcuna altra locomotiva, segnale oppure Decoder per deviatore.

CV per fx (MM) e DCC

Sotto fx (MM) l’indirizzo può venire impostato solo con il commutatore DIP. I valore in parentesi sono le impostazioni di fabbrica.

| CV | Significato | Valore | |
|------------|---|-------------|--|
| 1 | Indirizzi 1 - 255 | 1-255 (1) | solo DCC |
| 9 | Indirizzi 256 - 2040 | 0-7 (0) | solo DCC |
| 39 PoM* | Movimento lento | 0 (0) | |
| | Movimento a media velocità | 1 | |
| | Movimento rapido | 2 | |
| | Movimento a media velocità con rimbalzo | 3 | |
| | Movimento rapido con rimbalzo | 4 | |
| | Movimento a media velocità con rimbalzo ala 1 | 5 | solo nel caso 70411 / 70412 / 70413 / 70414 |
| | Movimento a media velocità con rimbalzo ala 2 | 6 | solo nel caso 70411 / 70412 / 70413 / 70414 |
| 40 PoM* | Illuminazione | 0 - 15 (15) | 0 luce spenta attenuazione 0-15, dove 15 = 100% uguale a luminosità |
| 41 PoM* | Posizione media ala 1 | 0 - 255 | Impostazione della posizione media per le ali di tutti i segnali |

| CV | Significato | Valore | |
|------------|-----------------------|---------|---|
| 42 PoM* | Posizione media ala 2 | 0 - 255 | solo nel caso 70411 / 70412 / 70413 / 70414 Impostazione della posizione media per la 2ª ala |



*La programmazione PoM avviene sul binario principale, purché essa venga supportata all’apparato di comando.

Impostazione e calcolo degli indirizzi maggiori di 255 (DCC):

Ad es. indirizzo 1044 -> 1044:256=4,078125 . Il valore prima della virgola (4) viene inserito in CV 9. Il valore dopo la virgola (0,078125) viene moltiplicato per 256: 0,078125x256=20. Il valore calcolato 20 deve venire inserito nella CV 1.

Esercizio sotto mfx

La registrazione mfx può avvenire sotto MM oppure DCC. È discriminante il tipo di funzionamento impostato tramite il commutatore Dip 10.

La registrazione mfx viene avviata con la CS2 60213/60214/60215 nella configurazione degli apparati elettromagnetici tramite  >  e con la CS3 60216/60226 nella configurazione degli apparati elettromagnetici tramite  > „ricerca apparati mfx“.

Avvertenza sull’iscrizione mfx con la CS2:

Possibilità di selezione „Assegnare automaticamente apparati elettromagnetici“ sotto „Setup“ >  > „Binario“.

Se colà è posto il segno di spunta la registrazione mfx avviene sul primo indirizzo libero nella CS2. Se il segno di spunta non è collocato, la registrazione mfx avviene sull’indirizzo effettivamente programmato sul Decoder.

Användningsområde

- Signal avsedd för inbyggnad i digitala H0-modelljärnvägar.
- Vid analog drift får signalen endast användas tillsammans med ställpult nr 72760.
- Signalen får endast användas i torra utrymmen.

Innehåll

- 1 Signal
- 1 Kabel med 2-polig stickkontakt, röd och brun
- 1 Kabel med 3-polig stickkontakt, röd och röd
- 1 Kabel med 3-polig stickkontakt, violett, röd-brun, röd-grön
- 2 Vinkelhållare för montage under anläggningen
- 1 Fästesplatta för C-räls
- 4 Isoleringar (röda) för C-räls (1 sats m. 4 st)
- 2 Mittledar-isoleringar (grå) för K-räls
- 1 Mittledar-anslutning för K-räls
- 1 Dekal för uppmärkning
- 1 Bruksanvisning med schablon för montage på anläggningens undersida
- 1 Garantisedel

För montage på anläggningens undersida behöver man följande verktyg: Skruvmejsel, 4 X skruvar med försänkskalle \emptyset 2,5 mm x (längden beroende på underlagets tjocklek), borr med \emptyset 16 mm och \emptyset 2 mm.

Säkerhetsföreskrifter

- **VARNING!** Funktionsbetingade vassa kanter och spetsar.
- **OBS!** Risk för farliga elstötar och risk för kroppsskada! Infästning av kablar, elanslutningar och montage får därför endast göras i spänningslöst tillstånd.

- **Signalen får endast matas med tillåten/korrekt spänning!** (Se tekniska data i bruksanvisningen.)

Viktig information

- Bruksanvisningen är en del av denna produkt och måste därför sparas och den skall medfölja vid överlåtelse av produkten till tredje man.
- För ev. reparation måste man vända sig till sin Märklin-fackhandlare.
- För hantering som avfall v.g. se: www.maerklin.com/en/im-print.html

Tekniska data

- Belastning ≤ 100 mA
- Belastning spårutgång max. 2 A
- Spänning max. 40 V

Funktioner

- Anpassade för multiprotokoll:fx (MM), mfx och DCC
- Inställning av drifttyp görs med DIP-switchar
- Inställbara adresser med DIP-switchar:
 - 1 – 256 fx (MM) (ControlUnit 6021)
 - 1 – 320 fx (MM) (Central Station 6021x/Mobile Station 60653)
 - 1 – 511 (DCC)
- Programmerbara adresser via CV
 - 1 – 2.040 DCC
- Ändring av egenskaper via CV
- Strömförsörjning via den digitala strömkretsen

Signal-inbyggnad

Innan signalen byggs in/kopplas in i anläggningen måste den programmeras.

Följande arbetsmoment får endast utföras i spänningslöst tillstånd:

Inställning av adresser och drifttyp med DIP-switchar:

- Inställning av drifttyp med DIP-switch 10
Switch 10 off = fx (MM) / mfx
Switch 10 on = DCC
- fx (MM)/DCC inställning av adresser med DIP-switchar (tabeller på sidan 28)

! Observera:

- Inställningar med DIP-switchar får endast göras i spänningslöst tillstånd! Signalen visar den aktuella inställningen först efter att elspänningen anslutits.
- **För att reglera signalerna 70413 och 70414** fordras 2 adresser (knapp-par). Den 2:a adressen anges automatiskt som följeadress. Denna följeadress **är inte fritt valbar**.

Programmering med CS 2 / CS 3

fx (MM)

CV-programmering måste göras via programmeringsspåret.

OBS! Endast en enda signal i taget får anslutas till programmeringsspåret.

Följande CV kan ändras med fx (MM): CV 39, 40, 41 och 42. Betr. CV 41 och 42 måste med fx (MM) värdet delas med 4, eftersom värdena 0 - 80 finns tillgängliga, t.ex. $255/4 = 64$ (avrundat).

Under pågående programmering blinkar signalens lyktor, ev.

avvikelser under programmeringen kan ändras med Central Station. Efter avslutad programmering är signalen ställd på "kör".

Hur programmering genomförs med hjälp av Control Unit 6021 återfinns på www.maerklin.de -> Service -> Technische Informationen.

Vid programmering med andra körkontroller: V.g. se bruksanvisningen till respektive körkontroll.

DCC

CV-programmering måste göras via programmeringsspåret. **OBS! Endast en enda signal** i taget får anslutas till programmeringsspåret. Under pågående dataöverföring blinkar som bekräftelse signalens lyktor.

Vid programmering med andra körkontroller: V.g. se bruksanvisningen till respektive körkontroll.

Programmering med MS 2

För att programmera signalerna med Mobile Station 2 måste ett nytt lokomotiv skrivas in under MM2 eller DCC.

Observera då att signalen som ska programmeras ska via decodern kodas för MM2 eller DCC, samt på samma adress som loket ställts in på. Det nyinskrivna loket används bara för programmering av signalen. Gå därför in på MS 2-meny, "konfigurerung av lok" och därefter på "CV-programmering".

Under CV-programmeringen får inga andra lok, signaler eller växeldkodrar vara anslutna eller aktiverade.

CV för fx (MM) och DCC

under fx (MM) kan adresserna endast ställas in med DIP-switcharna. Angivna värden inom klammer är fabriksinställningar.

| CV | Innebörd | Värde | |
|------|--|-------------|---|
| 1 | Adresser 1 - 255 | 1-255 (1) | endast DCC |
| 9 | Adresser 256 - 2040 | 0-7 (0) | endast DCC |
| 39 | Långsam rörelse | 0 (0) | |
| PoM* | Medelsnabb rörelse | 1 | |
| | Snabb rörelse | 2 | |
| | Medelsnabb rörelse med omställning | 3 | |
| | Snabb rörelse med omställning | 4 | |
| | Medelsnabb rörelse med omställning vinge 1 | 5 | endast för 70411 / 70412 / 70413 / 70414 |
| | Medelsnabb rörelse med omställning vinge 2 | 6 | endast för 70411 / 70412 / 70413 / 70414 |
| 40 | Belysning | 0 - 15 (15) | 0 ljuset släckt dimmer 0-15, varvid 15 = 100% ljusstyrka |
| PoM* | | | |
| 41 | Mellanläge vinge 1 | 0 - 255 | Inställning av mellanläge för samtliga signalers vingar |
| PoM* | | | |
| 42 | Mellanläge vinge 2 | 0 - 255 | endast för 70411 / 70412 / 70413 / 70414 inställning av mellanläge för vinge 2 |
| PoM* | | | |

*PoM programmering kan, om körkontrollen tillåter detta, göras via anläggningens huvudspår.

Inställning och beräkning av adresser större än 255 (DCC):



T.ex. Adress 1044 -> $1044:256=4,078125$. Värdet efter komma-

tecknet (0,078125) multipliceras med 256 $0,078125 \times 256 = 20$. Det framräknade värdet måste tas in i CV 1.

Körning med mfx

Mfx-inställning kan göras med både MM och DCC.

Drifttyp ställs in med hjälp av dip-switch nr 10.

Mfx-inställningen görs med CS2 60213/60214/60215 i magnetartikelkonfigurationen via  > 

och med CS3 60216/60226 i magnetartikelkonfigurationen via  > "sökning av mfx-artiklar".

Information om mfx-inställning med CS2:

Valmöjlighet: "Automatisk tilldelning av magnetartikel" under "Setup" >  > "spår".

Om man markerar detta val så genomförs mfx-inställningen på den första lediga adressen i CS2. Om man inte markerar detta så genomförs mfx-inställningen på den adress som dekodern redan är inställd på.

Hensigtsmæssig anvendelse

- Signalet er til indbygning i H0 digital-modelbaneanlæg.
- Signalet må til analogdrift kun anvendes med kontrolpanel 72760.
- Må kun anvendes i lukkede rum.

Leveringsomfang

- 1 signal
- 1 kabel med stik, 2-polet, rød og brun
- 1 kabel med stik, 3-polet, rød og rød
- 1 kabel med stik, 3-polet, violet, rød-brun, rød-grøn
- 2 holdebeslag til underhængt montering
- 1 holdeplads C-skinne
- 4 isoleringer (rød) C-skinne (1støbt)
- 2 mellemløder-isoleringer (grå) K-skinne
- 1 mellemløder-tilslutning K-skinne
- 1 overføringsbillede til mærkning
- Indbygningsvejledning med skabelon til underhængt montering
- Garantibevis

Værktøj, der skal bruges til underhængt montering: Skruetrækker, 4x nedsænkningsskruer \varnothing 2,5 mm x (længden afhænger af indbygningsdybden), bor \varnothing 16 mm og 2mm.

Sikkerhedsvejledning

- **BEMÆRK!** Funktionsbetingede skarpe kanter og spidser.
- Kabel- og monteringsopgaver må udelukkende foretages i spændingsfri tilstand. Manglende overholdelse kan føre til farlig strøm gennem kroppen og skader.
- **Signalet må kun drives med den tilladte spænding** (se tekniske data).

Vigtig information

- Betjeningsvejledningen er del af produktet og skal derfor opbevares sammen med produktet og gives videre til tredjemand sammen med produktet.
- Kontakt din Märklin-forhandler for reparationer.
- Bortskaffelse: www.maerklin.com/en/imprint.html

Tekniske data

- Belastning \leq 100 mA
- Belastning skinneudgang maks. 2 A
- Holdespænding maks. 40 V

Funktioner

- Mulig multiprotokol: fx (MM), mfx og DCC
- Indstilling af driftsform ved hjælp af DIP-kontakt
- Indstilling af adresser ved hjælp af DIP-kontakt:
 - 1 – 256 fx (MM) (Control Unit 6021)
 - 1 – 320 fx (MM) (Central Station 6021x/Mobile Station 60653)
 - 1 – 511 (DCC)
- Programmérbare adresser via CV
 - 1 – 2.040 DCC
- Ændring af egenskaber via CV
- Strømforsyning via digitalstrømkreds

Signalindbygning

Signalet skal programmeres inden indbygning.

Følgende arbejdsstrin må kun udføres i spændingsfri tilstand:

Indstilling af adresser og driftsform via DIP-kontakten:

- Indstilling af driftsform ved hjælp af DIP-kontakt 10
Kontakt 10 off = fx (MM) / mfx
Kontakt 10 on = DCC
- fx (MM)/DCC indstilling af adresser med DIP-kontakt (tabel fra side 28)

! Bemærk:

- Indstillinger med DIP-kontakten skal altid foretages i spændingsfri tilstand. Signalet genkender først den aktuelle kontaktindstilling, når spændingen aktiveres.
- **Til forbindelse af signalerne 70413 og 70414** skal der grundlæggende altid bruges 2 adresser (tastepar). Den 2. adresse indstilles automatisk som følgeadresse. Følgeadressen **kan ikke vælges**.

Programmering med CS 2 / CS 3

fx (MM)

CV-programmeringen skal foretages på programmeringsskinen. Der må altid **kun tilsluttes et signal** på programmeringsskinen.

Følgende CV'er kan ændres ved fx (MM): CV 39, 40, 41 og 42. Ved CV 41 og 42, skal ved fx (MM) værdien deles med 4, for kun værdierne 0-80 er tilladte, f. eks. $255/4 = 64$ (afrundet).

Signallampen blinker under programmeringen; uafhængigt deraf aktiveres signalet med Central Station under programmeringen. Efter afsluttet programmering, indstilles signalet på „Kørsel“.

Fremgangsmåden til programmering med Control Unit 6021 findes på www.maerklin.de -> Service -> Technische Informationen.

Beskrivelse af programmeringen med andre enheder findes i betjeningsvejledningen for den pågældende styreenhed.

DCC

CV-programmeringen skal foretages på programmeringsskinen. Der må altid **kun tilsluttes et signal** på programmeringsskinen. Signalets lampe blinker til kontrol under hele dataoverførslen. Beskrivelse af programmeringen med andre enheder findes i betjeningsvejledningen for den pågældende styreenhed.

Programmering med MS 2

Til programmering af signalerne med Mobile Station 2 skal der oprettes et nyt lokomotiv manuelt under MM2 eller DCC. Bemærk venligst, at det programmerede signal over koderingskontakten så også bliver indstillet på MM2 eller DCC samt den samme adresse som lokomotivet. Det nyoprettede lokomotiv skal kun bruges til programmering af signalerne. Åbn dertil menuen på MS 2 og gå til "Konfiguration af lokomotiv" og derefter "Programmering af CV".

Der må ikke være tilsluttet andre lokomotiver, signaler eller sporskiftedekodere under CV-programmeringen.

CV til fx (MM) og DCC

Under fx (MM) kan adressen kun indstilles med DIP-kontakten. Værdier i parentes er fabriksindstillingerne.

| CV | Betydning | Værdier | |
|----|---------------------|-----------|---------|
| 1 | Adresse 1 - 255 | 1-255 (1) | kun DCC |
| 9 | Adresser 256 - 2040 | 0-7 (0) | kun DCC |

| CV | Betydning | Værdier | |
|------|---|-------------|--|
| 39 | Langsom bevægelse | 0 (0) | |
| PoM* | Mellemhurtig bevægelse | 1 | |
| | Hurtig bevægelse | 2 | |
| | Mellemhurtig bevægelse med eftervip | 3 | |
| | Hurtig bevægelse med eftervip | 4 | |
| | Mellemhurtig bevægelse med eftervip Vinge 1 | 5 | kun for 70411 / 70412 / 70413 / 70414 |
| | Mellemhurtig bevægelse med eftervip Vinge 2 | 6 | kun for 70411 / 70412 / 70413 / 70414 |
| 40 | Belysning | 0 - 15 (15) | 0 lys fra dimmer 0-15, hvor 15 = svarer til 100 % lyshed |
| PoM* | | | |
| 41 | Mellemstilling Vinge 1 | 0 - 255 | Indstilling af mellemposition af alle signalers vinger |
| PoM* | | | |
| 42 | Mellemstilling Vinge 2 | 0 - 255 | kun for 70411 / 70412 / 70413 / 70414 Indstilling af mellemposition for 2. vinge |
| PoM* | | | |

*PoM kan programmeres på hovedskinnen, hvis det understøttes af styreenheden.



Indstilling og beregning af adresser større end 255 (DCC):

F. eks. adresse 1044 -> 1044:256=4,078125 . Værdien før komma (4) skal indtastes i CV 9. Værdien efter komma (0,078125) ganges med 256 (0,078125x256=20). Den beregnede værdi 20 indtastes i CV 1.

Drift med mfx

mfx-registreringen kan ske med MM eller DCC.

Den ved hjælp af dip-omskifter indstillede driftsmodus er afgørende.

mfx-registreringen indledes med CS2 60213/60214/60215 i magnetartikelkonfigurationen via  >  og med CS3 60216/60226 i magnetartikelkonfigurationen via  > „søg mfx-artikel“.

Vigtigt vedrørende mfx-registreringen med CS2:

Valgmulighed „tildel magnetartikel automatisk“ under „Setup“ >  > „Spor“.

Er fluebenet sat ved dette punkt, sker mfx-registreringen på de første frie adresser i CS2. Er fluebenet ikke sat ved dette punkt, sker mfx-registreringen på de effektivt ved dekoderen programmerede adresser.

Betriebsart und Adressen einstellen

Setting the mode of operation and addresses

Définir le mode d'exploitation et les adresses

Bedrijfsmodus en adres instellen

Configuración de modo de funcionamiento y direcciones

Impostate tipo di funzionamento e indirizzi



Ställ in driftstyp och adress



Indstil driftsart og adresser

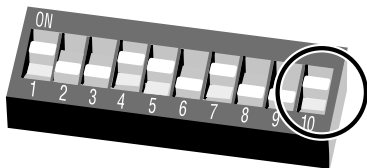

on = DCC



off = fx (MM)





| |  |  |  | | | | | | | 10 (0/1) |
|----|--|--|--|-------|-----|--|--|--|-------------|----------|
| 1 | 1 | 1 | 1 | | | | | | fx (MM)/DCC | |
| 2 | 1 | 2 | 2 | | | | | | fx (MM)/DCC | |
| 3 | 1 | 3 | 1 2 | | | | | | fx (MM)/DCC | |
| 4 | 1 | 4 | | 3 | | | | | fx (MM)/DCC | |
| 5 | 1 | 5 | 1 3 | | | | | | fx (MM)/DCC | |
| 6 | 1 | 6 | | 2 3 | | | | | fx (MM)/DCC | |
| 7 | 1 | 7 | 1 2 3 | | | | | | fx (MM)/DCC | |
| 8 | 1 | 8 | | | 4 | | | | fx (MM)/DCC | |
| 9 | 1 | 9 | 1 | | 4 | | | | fx (MM)/DCC | |
| 10 | 1 | 10 | | 2 4 | | | | | fx (MM)/DCC | |
| 11 | 1 | 11 | 1 2 | 4 | | | | | fx (MM)/DCC | |
| 12 | 1 | 12 | | 3 4 | | | | | fx (MM)/DCC | |
| 13 | 1 | 13 | 1 | 3 4 | | | | | fx (MM)/DCC | |
| 14 | 1 | 14 | | 2 3 4 | | | | | fx (MM)/DCC | |
| 15 | 1 | 15 | 1 2 3 4 | | | | | | fx (MM)/DCC | |
| 16 | 1 | 16 | | | 5 | | | | fx (MM)/DCC | |
| 17 | 2 | 1 | 1 | | 5 | | | | fx (MM)/DCC | |
| 18 | 2 | 2 | | 2 | 5 | | | | fx (MM)/DCC | |
| 19 | 2 | 3 | 1 2 | | 5 | | | | fx (MM)/DCC | |
| 20 | 2 | 4 | | 3 | 5 | | | | fx (MM)/DCC | |
| 21 | 2 | 5 | 1 | 3 | 5 | | | | fx (MM)/DCC | |
| 22 | 2 | 6 | | 2 3 | 5 | | | | fx (MM)/DCC | |
| 23 | 2 | 7 | 1 2 3 | | 5 | | | | fx (MM)/DCC | |
| 24 | 2 | 8 | | | 4 5 | | | | fx (MM)/DCC | |
| 25 | 2 | 9 | 1 | | 4 5 | | | | fx (MM)/DCC | |
| 26 | 2 | 10 | | 2 | 4 5 | | | | fx (MM)/DCC | |

| |  |  |  | 10 (0/1) | | | | |
|----|--|--|--|----------|-----|--|-------------|--|
| 27 | | 2 11 | 1 2 | 4 5 | | | fx (MM)/DCC | |
| 28 | | 2 12 | | 3 4 5 | | | fx (MM)/DCC | |
| 29 | | 2 13 | 1 | 3 4 5 | | | fx (MM)/DCC | |
| 30 | | 2 14 | | 2 3 4 5 | | | fx (MM)/DCC | |
| 31 | | 2 15 | 1 2 3 4 5 | | | | fx (MM)/DCC | |
| 32 | | 2 16 | | | 6 | | fx (MM)/DCC | |
| 33 | | 3 1 | 1 | | 6 | | fx (MM)/DCC | |
| 34 | | 3 2 | | 2 | 6 | | fx (MM)/DCC | |
| 35 | | 3 3 | 1 2 | | 6 | | fx (MM)/DCC | |
| 36 | | 3 4 | | 3 | 6 | | fx (MM)/DCC | |
| 37 | | 3 5 | 1 | 3 | 6 | | fx (MM)/DCC | |
| 38 | | 3 6 | | 2 3 | 6 | | fx (MM)/DCC | |
| 39 | | 3 7 | 1 2 3 | | 6 | | fx (MM)/DCC | |
| 40 | | 3 8 | | 4 | 6 | | fx (MM)/DCC | |
| 41 | | 3 9 | 1 | | 4 6 | | fx (MM)/DCC | |
| 42 | | 3 10 | | 2 | 4 6 | | fx (MM)/DCC | |
| 43 | | 3 11 | 1 2 | | 4 6 | | fx (MM)/DCC | |
| 44 | | 3 12 | | 3 4 | 6 | | fx (MM)/DCC | |
| 45 | | 3 13 | 1 | 3 4 | 6 | | fx (MM)/DCC | |
| 46 | | 3 14 | | 2 3 4 | 6 | | fx (MM)/DCC | |
| 47 | | 3 15 | 1 2 3 4 | | 6 | | fx (MM)/DCC | |
| 48 | | 3 16 | | | 5 6 | | fx (MM)/DCC | |
| 49 | | 4 1 | 1 | | 5 6 | | fx (MM)/DCC | |
| 50 | | 4 2 | | 2 | 5 6 | | fx (MM)/DCC | |
| 51 | | 4 3 | 1 2 | | 5 6 | | fx (MM)/DCC | |



| |  |  |  | 10 (0/1) | | | | |
|----|--|--|--|----------|-------|---|-------------|--|
| 52 | | 4 4 | | 3 | 5 6 | | fx (MM)/DCC | |
| 53 | | 4 5 | 1 | 3 | 5 6 | | fx (MM)/DCC | |
| 54 | | 4 6 | | 2 3 | 5 6 | | fx (MM)/DCC | |
| 55 | | 4 7 | 1 2 3 | | 5 6 | | fx (MM)/DCC | |
| 56 | | 4 8 | | | 4 5 6 | | fx (MM)/DCC | |
| 57 | | 4 9 | 1 | | 4 5 6 | | fx (MM)/DCC | |
| 58 | | 4 10 | | 2 | 4 5 6 | | fx (MM)/DCC | |
| 59 | | 4 11 | 1 2 | | 4 5 6 | | fx (MM)/DCC | |
| 60 | | 4 12 | | 3 | 4 5 6 | | fx (MM)/DCC | |
| 61 | | 4 13 | 1 | 3 | 4 5 6 | | fx (MM)/DCC | |
| 62 | | 4 14 | | 2 3 | 4 5 6 | | fx (MM)/DCC | |
| 63 | | 4 15 | 1 2 3 | | 4 5 6 | | fx (MM)/DCC | |
| 64 | | 4 16 | | | | 7 | fx (MM)/DCC | |
| 65 | | 5 1 | 1 | | | 7 | fx (MM)/DCC | |
| 66 | | 5 2 | | 2 | | 7 | fx (MM)/DCC | |
| 67 | | 5 3 | 1 2 | | | 7 | fx (MM)/DCC | |
| 68 | | 5 4 | | 3 | | 7 | fx (MM)/DCC | |
| 69 | | 5 5 | 1 | 3 | | 7 | fx (MM)/DCC | |
| 70 | | 5 6 | | 2 3 | | 7 | fx (MM)/DCC | |
| 71 | | 5 7 | 1 2 3 | | | 7 | fx (MM)/DCC | |
| 72 | | 5 8 | | | 4 | 7 | fx (MM)/DCC | |
| 73 | | 5 9 | 1 | | 4 | 7 | fx (MM)/DCC | |
| 74 | | 5 10 | | 2 | 4 | 7 | fx (MM)/DCC | |
| 75 | | 5 11 | 1 2 | | 4 | 7 | fx (MM)/DCC | |
| 76 | | 5 12 | | 3 4 | | 7 | fx (MM)/DCC | |



|  |  | |  | | | | | | | 10 (0/1) | |
|--|--|----|--|---|---|---|---|---|---|----------|-------------|
| | 1 | 2 | 3 | 4 | 5 | 6 | 7 | 8 | 9 | | 0 |
| 77 | 5 | 13 | 1 | | 3 | 4 | | | 7 | | fx (MM)/DCC |
| 78 | 5 | 14 | | 2 | 3 | 4 | | | 7 | | fx (MM)/DCC |
| 79 | 5 | 15 | 1 | 2 | 3 | 4 | | | 7 | | fx (MM)/DCC |
| 80 | 5 | 16 | | | | | 5 | | 7 | | fx (MM)/DCC |
| 81 | 6 | 1 | 1 | | | | 5 | | 7 | | fx (MM)/DCC |
| 82 | 6 | 2 | | 2 | | | 5 | | 7 | | fx (MM)/DCC |
| 83 | 6 | 3 | 1 | 2 | | | 5 | | 7 | | fx (MM)/DCC |
| 84 | 6 | 4 | | | 3 | | 5 | | 7 | | fx (MM)/DCC |
| 85 | 6 | 5 | 1 | | 3 | | 5 | | 7 | | fx (MM)/DCC |
| 86 | 6 | 6 | | 2 | 3 | | 5 | | 7 | | fx (MM)/DCC |
| 87 | 6 | 7 | 1 | 2 | 3 | | 5 | | 7 | | fx (MM)/DCC |
| 88 | 6 | 8 | | | | 4 | 5 | | 7 | | fx (MM)/DCC |
| 89 | 6 | 9 | 1 | | | 4 | 5 | | 7 | | fx (MM)/DCC |
| 90 | 6 | 10 | | 2 | | 4 | 5 | | 7 | | fx (MM)/DCC |
| 91 | 6 | 11 | 1 | 2 | | 4 | 5 | | 7 | | fx (MM)/DCC |
| 92 | 6 | 12 | | | 3 | 4 | 5 | | 7 | | fx (MM)/DCC |
| 93 | 6 | 13 | 1 | | 3 | 4 | 5 | | 7 | | fx (MM)/DCC |
| 94 | 6 | 14 | | 2 | 3 | 4 | 5 | | 7 | | fx (MM)/DCC |
| 95 | 6 | 15 | 1 | 2 | 3 | 4 | 5 | | 7 | | fx (MM)/DCC |
| 96 | 6 | 16 | | | | | | 6 | 7 | | fx (MM)/DCC |
| 97 | 7 | 1 | 1 | | | | | 6 | 7 | | fx (MM)/DCC |
| 98 | 7 | 2 | | 2 | | | | 6 | 7 | | fx (MM)/DCC |
| 99 | 7 | 3 | 1 | 2 | | | | 6 | 7 | | fx (MM)/DCC |
| 100 | 7 | 4 | | | 3 | | | 6 | 7 | | fx (MM)/DCC |
| 101 | 7 | 5 | 1 | | 3 | | | 6 | 7 | | fx (MM)/DCC |



|  |  | |  | | | | | | | 10 (0/1) | |
|--|--|----|--|---|---|---|---|---|---|----------|-------------|
| | 1 | 2 | 3 | 4 | 5 | 6 | 7 | 8 | 9 | | 0 |
| 102 | 7 | 6 | | | 2 | 3 | | | 6 | 7 | fx (MM)/DCC |
| 103 | 7 | 7 | 1 | 2 | 3 | | | | 6 | 7 | fx (MM)/DCC |
| 104 | 7 | 8 | | | | 4 | | 6 | 7 | | fx (MM)/DCC |
| 105 | 7 | 9 | 1 | | | 4 | | 6 | 7 | | fx (MM)/DCC |
| 106 | 7 | 10 | | 2 | | 4 | | 6 | 7 | | fx (MM)/DCC |
| 107 | 7 | 11 | 1 | 2 | | 4 | | 6 | 7 | | fx (MM)/DCC |
| 108 | 7 | 12 | | | 3 | 4 | | 6 | 7 | | fx (MM)/DCC |
| 109 | 7 | 13 | 1 | | 3 | 4 | | 6 | 7 | | fx (MM)/DCC |
| 110 | 7 | 14 | | 2 | 3 | 4 | | 6 | 7 | | fx (MM)/DCC |
| 111 | 7 | 15 | 1 | 2 | 3 | 4 | | 6 | 7 | | fx (MM)/DCC |
| 112 | 7 | 16 | | | | | 5 | 6 | 7 | | fx (MM)/DCC |
| 113 | 8 | 1 | 1 | | | | 5 | 6 | 7 | | fx (MM)/DCC |
| 114 | 8 | 2 | | 2 | | | 5 | 6 | 7 | | fx (MM)/DCC |
| 115 | 8 | 3 | 1 | 2 | | | 5 | 6 | 7 | | fx (MM)/DCC |
| 116 | 8 | 4 | | | 3 | | 5 | 6 | 7 | | fx (MM)/DCC |
| 117 | 8 | 5 | 1 | | 3 | | 5 | 6 | 7 | | fx (MM)/DCC |
| 118 | 8 | 6 | | 2 | 3 | | 5 | 6 | 7 | | fx (MM)/DCC |
| 119 | 8 | 7 | 1 | 2 | 3 | | 5 | 6 | 7 | | fx (MM)/DCC |
| 120 | 8 | 8 | | | | 4 | 5 | 6 | 7 | | fx (MM)/DCC |
| 121 | 8 | 9 | 1 | | | 4 | 5 | 6 | 7 | | fx (MM)/DCC |
| 122 | 8 | 10 | | 2 | | 4 | 5 | 6 | 7 | | fx (MM)/DCC |
| 123 | 8 | 11 | 1 | 2 | | 4 | 5 | 6 | 7 | | fx (MM)/DCC |
| 124 | 8 | 12 | | | 3 | 4 | 5 | 6 | 7 | | fx (MM)/DCC |
| 125 | 8 | 13 | 1 | | 3 | 4 | 5 | 6 | 7 | | fx (MM)/DCC |
| 126 | 8 | 14 | | 2 | 3 | 4 | 5 | 6 | 7 | | fx (MM)/DCC |
| 127 | 8 | 15 | 1 | 2 | 3 | 4 | 5 | 6 | 7 | | fx (MM)/DCC |



| Key | Keyboard | | ON | | | | | | | 10 (0/1) | Function | | |
|-----|----------|----|----|---|---|---|---|---|---|----------|----------|---|-------------|
| | 0 | 1 | 1 | 2 | 3 | 4 | 5 | 6 | 7 | | | 8 | 9 |
| 128 | 8 | 16 | | | | | | | | 8 | | | fx (MM)/DCC |
| 129 | 9 | 1 | 1 | | | | | | | 8 | | | fx (MM)/DCC |
| 130 | 9 | 2 | | 2 | | | | | | 8 | | | fx (MM)/DCC |
| 131 | 9 | 3 | 1 | 2 | | | | | | 8 | | | fx (MM)/DCC |
| 132 | 9 | 4 | | | 3 | | | | | 8 | | | fx (MM)/DCC |
| 133 | 9 | 5 | 1 | 3 | | | | | | 8 | | | fx (MM)/DCC |
| 134 | 9 | 6 | | 2 | 3 | | | | | 8 | | | fx (MM)/DCC |
| 135 | 9 | 7 | 1 | 2 | 3 | | | | | 8 | | | fx (MM)/DCC |
| 136 | 9 | 8 | | | 4 | | | | | 8 | | | fx (MM)/DCC |
| 137 | 9 | 9 | 1 | | 4 | | | | | 8 | | | fx (MM)/DCC |
| 138 | 9 | 10 | | 2 | 4 | | | | | 8 | | | fx (MM)/DCC |
| 139 | 9 | 11 | 1 | 2 | 4 | | | | | 8 | | | fx (MM)/DCC |
| 140 | 9 | 12 | | | 3 | 4 | | | | 8 | | | fx (MM)/DCC |
| 141 | 9 | 13 | 1 | | 3 | 4 | | | | 8 | | | fx (MM)/DCC |
| 142 | 9 | 14 | | 2 | 3 | 4 | | | | 8 | | | fx (MM)/DCC |
| 143 | 9 | 15 | 1 | 2 | 3 | 4 | | | | 8 | | | fx (MM)/DCC |
| 144 | 9 | 16 | | | | 5 | | | | 8 | | | fx (MM)/DCC |
| 145 | 10 | 1 | 1 | | | 5 | | | | 8 | | | fx (MM)/DCC |
| 146 | 10 | 2 | | 2 | | 5 | | | | 8 | | | fx (MM)/DCC |
| 147 | 10 | 3 | 1 | 2 | | 5 | | | | 8 | | | fx (MM)/DCC |
| 148 | 10 | 4 | | | 3 | 5 | | | | 8 | | | fx (MM)/DCC |
| 149 | 10 | 5 | 1 | | 3 | 5 | | | | 8 | | | fx (MM)/DCC |
| 150 | 10 | 6 | | 2 | 3 | 5 | | | | 8 | | | fx (MM)/DCC |
| 151 | 10 | 7 | 1 | 2 | 3 | 5 | | | | 8 | | | fx (MM)/DCC |
| 152 | 10 | 8 | | | 4 | 5 | | | | 8 | | | fx (MM)/DCC |
| 153 | 10 | 9 | 1 | | 4 | 5 | | | | 8 | | | fx (MM)/DCC |



| Key | Keyboard | | ON | | | | | | | 10 (0/1) | Function | | |
|-----|----------|----|----|---|---|---|---|---|---|----------|----------|---|-------------|
| | 0 | 1 | 1 | 2 | 3 | 4 | 5 | 6 | 7 | | | 8 | 9 |
| 154 | 10 | 10 | | 2 | 4 | 5 | | | 8 | | | | fx (MM)/DCC |
| 155 | 10 | 11 | 1 | 2 | 4 | 5 | | | 8 | | | | fx (MM)/DCC |
| 156 | 10 | 12 | | | 3 | 4 | 5 | | 8 | | | | fx (MM)/DCC |
| 157 | 10 | 13 | 1 | | 3 | 4 | 5 | | 8 | | | | fx (MM)/DCC |
| 158 | 10 | 14 | | 2 | 3 | 4 | 5 | | 8 | | | | fx (MM)/DCC |
| 159 | 10 | 15 | 1 | 2 | 3 | 4 | 5 | | 8 | | | | fx (MM)/DCC |
| 160 | 10 | 16 | | | | | | 6 | 8 | | | | fx (MM)/DCC |
| 161 | 11 | 1 | 1 | | | | | 6 | 8 | | | | fx (MM)/DCC |
| 162 | 11 | 2 | | 2 | | | | 6 | 8 | | | | fx (MM)/DCC |
| 163 | 11 | 3 | 1 | 2 | | | | 6 | 8 | | | | fx (MM)/DCC |
| 164 | 11 | 4 | | | 3 | | | 6 | 8 | | | | fx (MM)/DCC |
| 165 | 11 | 5 | 1 | | 3 | | | 6 | 8 | | | | fx (MM)/DCC |
| 166 | 11 | 6 | | 2 | 3 | | | 6 | 8 | | | | fx (MM)/DCC |
| 167 | 11 | 7 | 1 | 2 | 3 | | | 6 | 8 | | | | fx (MM)/DCC |
| 168 | 11 | 8 | | | | 4 | | 6 | 8 | | | | fx (MM)/DCC |
| 169 | 11 | 9 | 1 | | | 4 | | 6 | 8 | | | | fx (MM)/DCC |
| 170 | 11 | 10 | | 2 | | 4 | | 6 | 8 | | | | fx (MM)/DCC |
| 171 | 11 | 11 | 1 | 2 | | 4 | | 6 | 8 | | | | fx (MM)/DCC |
| 172 | 11 | 12 | | | 3 | 4 | | 6 | 8 | | | | fx (MM)/DCC |
| 173 | 11 | 13 | 1 | | 3 | 4 | | 6 | 8 | | | | fx (MM)/DCC |
| 174 | 11 | 14 | | 2 | 3 | 4 | | 6 | 8 | | | | fx (MM)/DCC |
| 175 | 11 | 15 | 1 | 2 | 3 | 4 | | 6 | 8 | | | | fx (MM)/DCC |
| 176 | 11 | 16 | | | | | 5 | 6 | 8 | | | | fx (MM)/DCC |
| 177 | 12 | 1 | 1 | | | | 5 | 6 | 8 | | | | fx (MM)/DCC |
| 178 | 12 | 2 | | 2 | | | 5 | 6 | 8 | | | | fx (MM)/DCC |
| 179 | 12 | 3 | 1 | 2 | | | 5 | 6 | 8 | | | | fx (MM)/DCC |



| |  |  |  | | | | | | | 10 (0/1) | |
|-----|--|--|--|-----------|---------|-----|-----|---|---|----------|-------------|
| | | | 1 | 2 | 3 | 4 | 5 | 6 | 7 | 8 | 9 |
| 180 | | 12 4 | | | 3 | 5 6 | 8 | | | | fx (MM)/DCC |
| 181 | | 12 5 | 1 | | 3 | 5 6 | 8 | | | | fx (MM)/DCC |
| 182 | | 12 6 | | 2 3 | | 5 6 | 8 | | | | fx (MM)/DCC |
| 183 | | 12 7 | 1 2 3 | | | 5 6 | 8 | | | | fx (MM)/DCC |
| 184 | | 12 8 | | | 4 5 6 | 8 | | | | | fx (MM)/DCC |
| 185 | | 12 9 | 1 | | 4 5 6 | 8 | | | | | fx (MM)/DCC |
| 186 | | 12 10 | | 2 | 4 5 6 | 8 | | | | | fx (MM)/DCC |
| 187 | | 12 11 | 1 2 | | 4 5 6 | 8 | | | | | fx (MM)/DCC |
| 188 | | 12 12 | | | 3 4 5 6 | 8 | | | | | fx (MM)/DCC |
| 189 | | 12 13 | 1 | | 3 4 5 6 | 8 | | | | | fx (MM)/DCC |
| 190 | | 12 14 | | 2 3 4 5 6 | 8 | | | | | | fx (MM)/DCC |
| 191 | | 12 15 | 1 2 3 4 5 6 | 8 | | | | | | | fx (MM)/DCC |
| 192 | | 12 16 | | | | | 7 8 | | | | fx (MM)/DCC |
| 193 | | 13 1 | 1 | | | | 7 8 | | | | fx (MM)/DCC |
| 194 | | 13 2 | | 2 | | | 7 8 | | | | fx (MM)/DCC |
| 195 | | 13 3 | 1 2 | | | | 7 8 | | | | fx (MM)/DCC |
| 196 | | 13 4 | | | 3 | | 7 8 | | | | fx (MM)/DCC |
| 197 | | 13 5 | 1 3 | | | | 7 8 | | | | fx (MM)/DCC |
| 198 | | 13 6 | | 2 3 | | | 7 8 | | | | fx (MM)/DCC |
| 199 | | 13 7 | 1 2 3 | | | | 7 8 | | | | fx (MM)/DCC |
| 200 | | 13 8 | | | 4 | | 7 8 | | | | fx (MM)/DCC |
| 201 | | 13 9 | 1 | | 4 | | 7 8 | | | | fx (MM)/DCC |
| 202 | | 13 10 | | 2 | 4 | | 7 8 | | | | fx (MM)/DCC |
| 203 | | 13 11 | 1 2 | | 4 | | 7 8 | | | | fx (MM)/DCC |
| 204 | | 13 12 | | | 3 4 | | 7 8 | | | | fx (MM)/DCC |
| 205 | | 13 13 | 1 | | 3 4 | | 7 8 | | | | fx (MM)/DCC |



| |  |  |  | | | | | | | 10 (0/1) | |
|-----|--|--|--|---------|-------|---|-------|-----|---|----------|-------------|
| | | | 1 | 2 | 3 | 4 | 5 | 6 | 7 | 8 | 9 |
| 206 | | 13 14 | | | 2 3 4 | | | 7 8 | | | fx (MM)/DCC |
| 207 | | 13 15 | 1 2 3 4 | | | | | 7 8 | | | fx (MM)/DCC |
| 208 | | 13 16 | | | | 5 | | 7 8 | | | fx (MM)/DCC |
| 209 | | 14 1 | 1 | | | 5 | | 7 8 | | | fx (MM)/DCC |
| 210 | | 14 2 | | 2 | | 5 | | 7 8 | | | fx (MM)/DCC |
| 211 | | 14 3 | 1 2 | | | 5 | | 7 8 | | | fx (MM)/DCC |
| 212 | | 14 4 | | | 3 | 5 | | 7 8 | | | fx (MM)/DCC |
| 213 | | 14 5 | 1 | | 3 | 5 | | 7 8 | | | fx (MM)/DCC |
| 214 | | 14 6 | | 2 3 | | 5 | | 7 8 | | | fx (MM)/DCC |
| 215 | | 14 7 | 1 2 3 | | | 5 | | 7 8 | | | fx (MM)/DCC |
| 216 | | 14 8 | | | 4 5 | | | 7 8 | | | fx (MM)/DCC |
| 217 | | 14 9 | 1 | | 4 5 | | | 7 8 | | | fx (MM)/DCC |
| 218 | | 14 10 | | 2 | 4 5 | | | 7 8 | | | fx (MM)/DCC |
| 219 | | 14 11 | 1 2 | | 4 5 | | | 7 8 | | | fx (MM)/DCC |
| 220 | | 14 12 | | | 3 4 5 | | | 7 8 | | | fx (MM)/DCC |
| 221 | | 14 13 | 1 | | 3 4 5 | | | 7 8 | | | fx (MM)/DCC |
| 222 | | 14 14 | | 2 3 4 5 | | | | 7 8 | | | fx (MM)/DCC |
| 223 | | 14 15 | 1 2 3 4 5 | | | | | 7 8 | | | fx (MM)/DCC |
| 224 | | 14 16 | | | | | 6 7 8 | | | | fx (MM)/DCC |
| 225 | | 15 1 | 1 | | | | 6 7 8 | | | | fx (MM)/DCC |
| 226 | | 15 2 | | 2 | | | 6 7 8 | | | | fx (MM)/DCC |
| 227 | | 15 3 | 1 2 | | | | 6 7 8 | | | | fx (MM)/DCC |
| 228 | | 15 4 | | | 3 | | 6 7 8 | | | | fx (MM)/DCC |
| 229 | | 15 5 | 1 | | 3 | | 6 7 8 | | | | fx (MM)/DCC |
| 230 | | 15 6 | | 2 3 | | | 6 7 8 | | | | fx (MM)/DCC |
| 231 | | 15 7 | 1 2 3 | | | | 6 7 8 | | | | fx (MM)/DCC |



| |  |  |  | 10 (0/1) | | | | | | | |
|-----|--|--|--|----------|---|---|---|---|-------------|-------------|-------------|
| 232 | 15 | 8 | | | 4 | 6 | 7 | 8 | fx (MM)/DCC | | |
| 233 | 15 | 9 | 1 | | 4 | 6 | 7 | 8 | fx (MM)/DCC | | |
| 234 | 15 | 10 | | 2 | 4 | 6 | 7 | 8 | fx (MM)/DCC | | |
| 235 | 15 | 11 | 1 | 2 | 4 | 6 | 7 | 8 | fx (MM)/DCC | | |
| 236 | 15 | 12 | | | 3 | 4 | 6 | 7 | 8 | fx (MM)/DCC | |
| 237 | 15 | 13 | 1 | | 3 | 4 | 6 | 7 | 8 | fx (MM)/DCC | |
| 238 | 15 | 14 | | 2 | 3 | 4 | 6 | 7 | 8 | fx (MM)/DCC | |
| 239 | 15 | 15 | 1 | 2 | 3 | 4 | 6 | 7 | 8 | fx (MM)/DCC | |
| 240 | 15 | 16 | | | | 5 | 6 | 7 | 8 | fx (MM)/DCC | |
| 241 | 16 | 1 | 1 | | | 5 | 6 | 7 | 8 | fx (MM)/DCC | |
| 242 | 16 | 2 | | 2 | | 5 | 6 | 7 | 8 | fx (MM)/DCC | |
| 243 | 16 | 3 | 1 | 2 | | 5 | 6 | 7 | 8 | fx (MM)/DCC | |
| 244 | 16 | 4 | | | 3 | 5 | 6 | 7 | 8 | fx (MM)/DCC | |
| 245 | 16 | 5 | 1 | | 3 | 5 | 6 | 7 | 8 | fx (MM)/DCC | |
| 246 | 16 | 6 | | 2 | 3 | 5 | 6 | 7 | 8 | fx (MM)/DCC | |
| 247 | 16 | 7 | 1 | 2 | 3 | 5 | 6 | 7 | 8 | fx (MM)/DCC | |
| 248 | 16 | 8 | | | 4 | 5 | 6 | 7 | 8 | fx (MM)/DCC | |
| 249 | 16 | 9 | 1 | | 4 | 5 | 6 | 7 | 8 | fx (MM)/DCC | |
| 250 | 16 | 10 | | 2 | 4 | 5 | 6 | 7 | 8 | fx (MM)/DCC | |
| 251 | 16 | 11 | 1 | 2 | | 4 | 5 | 6 | 7 | 8 | fx (MM)/DCC |
| 252 | 16 | 12 | | | 3 | 4 | 5 | 6 | 7 | 8 | fx (MM)/DCC |
| 253 | 16 | 13 | 1 | | 3 | 4 | 5 | 6 | 7 | 8 | fx (MM)/DCC |
| 254 | 16 | 14 | | 2 | 3 | 4 | 5 | 6 | 7 | 8 | fx (MM)/DCC |
| 255 | 16 | 15 | 1 | 2 | 3 | 4 | 5 | 6 | 7 | 8 | fx (MM)/DCC |
| 256 | 16 | 16 | | | | | | | 9 | fx (MM)/DCC | |
| 257 | 17 | 1 | 1 | | | | | | 9 | fx (MM)/DCC | |



| |  |  |  | 10 (0/1) | | | | | | |
|-----|--|--|--|----------|---|---|---|---|---|-------------|
| 258 | 17 | 2 | | | 2 | | | | 9 | fx (MM)/DCC |
| 259 | 17 | 3 | 1 | 2 | | | | | 9 | fx (MM)/DCC |
| 260 | 17 | 4 | | | | 3 | | | 9 | fx (MM)/DCC |
| 261 | 17 | 5 | 1 | | 3 | | | | 9 | fx (MM)/DCC |
| 262 | 17 | 6 | | | 2 | 3 | | | 9 | fx (MM)/DCC |
| 263 | 17 | 7 | 1 | 2 | 3 | | | | 9 | fx (MM)/DCC |
| 264 | 17 | 8 | | | | | 4 | | 9 | fx (MM)/DCC |
| 265 | 17 | 9 | 1 | | | | 4 | | 9 | fx (MM)/DCC |
| 266 | 17 | 10 | | | 2 | | 4 | | 9 | fx (MM)/DCC |
| 267 | 17 | 11 | 1 | 2 | | | 4 | | 9 | fx (MM)/DCC |
| 268 | 17 | 12 | | | | 3 | 4 | | 9 | fx (MM)/DCC |
| 269 | 17 | 13 | 1 | | 3 | 4 | | | 9 | fx (MM)/DCC |
| 270 | 17 | 14 | | | 2 | 3 | 4 | | 9 | fx (MM)/DCC |
| 271 | 17 | 15 | 1 | 2 | 3 | 4 | | | 9 | fx (MM)/DCC |
| 272 | 17 | 16 | | | | | | 5 | 9 | fx (MM)/DCC |
| 273 | 18 | 1 | 1 | | | | | 5 | 9 | fx (MM)/DCC |
| 274 | 18 | 2 | | | 2 | | | 5 | 9 | fx (MM)/DCC |
| 275 | 18 | 3 | 1 | 2 | | | | 5 | 9 | fx (MM)/DCC |
| 276 | 18 | 4 | | | | 3 | | 5 | 9 | fx (MM)/DCC |
| 277 | 18 | 5 | 1 | | 3 | | | 5 | 9 | fx (MM)/DCC |
| 278 | 18 | 6 | | | 2 | 3 | | 5 | 9 | fx (MM)/DCC |
| 279 | 18 | 7 | 1 | 2 | 3 | | | 5 | 9 | fx (MM)/DCC |
| 280 | 18 | 8 | | | | | 4 | 5 | 9 | fx (MM)/DCC |
| 281 | 18 | 9 | 1 | | | | 4 | 5 | 9 | fx (MM)/DCC |
| 282 | 18 | 10 | | | 2 | | 4 | 5 | 9 | fx (MM)/DCC |
| 283 | 18 | 11 | 1 | 2 | | | 4 | 5 | 9 | fx (MM)/DCC |



| |  |  | | | | | | | | | | | |
|-----|--|--|---|---|---|---|---|---|--|--|---|-------------|--|
| | | 10 (0/1) | | | | | | | | | | | |
| 284 | 18 | 12 | | | 3 | 4 | 5 | | | | 9 | fx (MM)/DCC | |
| 285 | 18 | 13 | 1 | | 3 | 4 | 5 | | | | 9 | fx (MM)/DCC | |
| 286 | 18 | 14 | | 2 | 3 | 4 | 5 | | | | 9 | fx (MM)/DCC | |
| 287 | 18 | 15 | 1 | 2 | 3 | 4 | 5 | | | | 9 | fx (MM)/DCC | |
| 288 | 18 | 16 | | | | | | 6 | | | 9 | fx (MM)/DCC | |
| 289 | 19 | 1 | 1 | | | | | 6 | | | 9 | fx (MM)/DCC | |
| 290 | 19 | 2 | | 2 | | | | 6 | | | 9 | fx (MM)/DCC | |
| 291 | 19 | 3 | 1 | 2 | | | | 6 | | | 9 | fx (MM)/DCC | |
| 292 | 19 | 4 | | | 3 | | | 6 | | | 9 | fx (MM)/DCC | |
| 293 | 19 | 5 | 1 | | 3 | | | 6 | | | 9 | fx (MM)/DCC | |
| 294 | 19 | 6 | | 2 | 3 | | | 6 | | | 9 | fx (MM)/DCC | |
| 295 | 19 | 7 | 1 | 2 | 3 | | | 6 | | | 9 | fx (MM)/DCC | |
| 296 | 19 | 8 | | | | 4 | | 6 | | | 9 | fx (MM)/DCC | |
| 297 | 19 | 9 | 1 | | | 4 | | 6 | | | 9 | fx (MM)/DCC | |
| 298 | 19 | 10 | | 2 | | 4 | | 6 | | | 9 | fx (MM)/DCC | |
| 299 | 19 | 11 | 1 | 2 | | 4 | | 6 | | | 9 | fx (MM)/DCC | |
| 300 | 19 | 12 | | | 3 | 4 | | 6 | | | 9 | fx (MM)/DCC | |
| 301 | 19 | 13 | 1 | | 3 | 4 | | 6 | | | 9 | fx (MM)/DCC | |
| 302 | 19 | 14 | | 2 | 3 | 4 | | 6 | | | 9 | fx (MM)/DCC | |
| 303 | 19 | 15 | 1 | 2 | 3 | 4 | | 6 | | | 9 | fx (MM)/DCC | |
| 304 | 19 | 16 | | | | | 5 | 6 | | | 9 | fx (MM)/DCC | |
| 305 | 20 | 1 | 1 | | | | 5 | 6 | | | 9 | fx (MM)/DCC | |
| 306 | 20 | 2 | | 2 | | | 5 | 6 | | | 9 | fx (MM)/DCC | |
| 307 | 20 | 3 | 1 | 2 | | | 5 | 6 | | | 9 | fx (MM)/DCC | |
| 308 | 20 | 4 | | | 3 | | 5 | 6 | | | 9 | fx (MM)/DCC | |
| 309 | 20 | 5 | 1 | | 3 | | 5 | 6 | | | 9 | fx (MM)/DCC | |

| |  |  | | | | | | | | | | | |
|-----|--|--|---|---|---|---|---|---|---|---|-------------|--|--|
| | | 10 (0/1) | | | | | | | | | | | |
| 310 | 20 | 6 | | 2 | 3 | | 5 | 6 | | 9 | fx (MM)/DCC | | |
| 311 | 20 | 7 | 1 | 2 | 3 | | 5 | 6 | | 9 | fx (MM)/DCC | | |
| 312 | 20 | 8 | | | | 4 | 5 | 6 | | 9 | fx (MM)/DCC | | |
| 313 | 20 | 9 | 1 | | | 4 | 5 | 6 | | 9 | fx (MM)/DCC | | |
| 314 | 20 | 10 | | 2 | | 4 | 5 | 6 | | 9 | fx (MM)/DCC | | |
| 315 | 20 | 11 | 1 | 2 | | 4 | 5 | 6 | | 9 | fx (MM)/DCC | | |
| 316 | 20 | 12 | | | 3 | 4 | 5 | 6 | | 9 | fx (MM)/DCC | | |
| 317 | 20 | 13 | 1 | | 3 | 4 | 5 | 6 | | 9 | fx (MM)/DCC | | |
| 318 | 20 | 14 | | 2 | 3 | 4 | 5 | 6 | | 9 | fx (MM)/DCC | | |
| 319 | 20 | 15 | 1 | 2 | 3 | 4 | 5 | 6 | | 9 | fx (MM)/DCC | | |
| 320 | 20 | 16 | | | | | | 7 | | 9 | fx (MM)/DCC | | |
| 321 | 21 | 1 | 1 | | | | | 7 | 9 | | ---/DCC | | |
| 322 | 21 | 2 | | 2 | | | | 7 | 9 | | ---/DCC | | |
| 323 | 21 | 3 | 1 | 2 | | | | 7 | 9 | | ---/DCC | | |
| 324 | 21 | 4 | | | 3 | | | 7 | 9 | | ---/DCC | | |
| 325 | 21 | 5 | 1 | | 3 | | | 7 | 9 | | ---/DCC | | |
| 326 | 21 | 6 | | 2 | 3 | | | 7 | 9 | | ---/DCC | | |
| 327 | 21 | 7 | 1 | 2 | 3 | | | 7 | 9 | | ---/DCC | | |
| 328 | 21 | 8 | | | | 4 | | 7 | 9 | | ---/DCC | | |
| 329 | 21 | 9 | 1 | | | 4 | | 7 | 9 | | ---/DCC | | |
| 330 | 21 | 10 | | 2 | | 4 | | 7 | 9 | | ---/DCC | | |
| 331 | 21 | 11 | 1 | 2 | | 4 | | 7 | 9 | | ---/DCC | | |
| 332 | 21 | 12 | | | 3 | 4 | | 7 | 9 | | ---/DCC | | |
| 333 | 21 | 13 | 1 | | 3 | 4 | | 7 | 9 | | ---/DCC | | |
| 334 | 21 | 14 | | 2 | 3 | 4 | | 7 | 9 | | ---/DCC | | |
| 335 | 21 | 15 | 1 | 2 | 3 | 4 | | 7 | 9 | | ---/DCC | | |

|  |  | | | | | | | | | |  | | | | | | | | | | 10 (0/1) | | | | | | | | | | | | | | | | | | | | | | | | | | | | | | | | | | | | | | | | | | | | | | | | | | | | | | | | | | | | | | | | | | | | | | | | | | | | | | | | | | | | | | | | | | | | | | | | | | | | | | | | | | | | | | | | | | | | | | | | | | | | | | | | | | | | | | | | | | | | | | | | | | | | | | | | | | | | | | | | | | | | | | | | | | | | | | | | | | | | | | | | | | | | | | | | | | | | | | | | | | | | | | | | | | | | | | | | | | | | | | | | | | | | | | | | | | | | | | | | | | | | | | | | | | | | | | | | | | | | | | | | | | | | | | | | | | | | | | | | | | | | | | | | | | | | | | | | | | | | | | | | | | | | | | | | | | | | | | | |
|--|--|----|----|--|--|--|--|---|---|---|--|---|-----|-----|----|---|---|--|--|--|----------|---|---|-----|---|-----|-----|----|---|--|---|--|--|---|---|---|-----|---|-----|-----|----|---|---|---|--|--|---|---|---|-----|---|-----|-----|----|---|--|--|---|--|---|---|---|-----|---|-----|-----|----|---|---|--|---|--|---|---|---|-----|---|-----|-----|----|---|--|---|---|--|---|---|---|-----|---|-----|-----|----|---|---|---|---|--|---|---|---|-----|---|-----|-----|----|---|--|--|--|---|---|---|---|-----|---|-----|-----|----|---|---|--|--|--|---|---|---|---|-----|---|-----|-----|----|----|--|---|--|--|---|---|---|---|-----|---|-----|-----|----|----|---|---|--|--|---|---|---|---|-----|---|-----|-----|----|----|--|--|---|---|---|---|---|-----|---|-----|-----|----|----|---|--|---|---|---|---|---|-----|---|-----|-----|----|----|--|---|---|---|---|---|---|-----|---|-----|-----|----|----|---|---|---|---|---|---|---|-----|---|-----|-----|----|----|--|--|--|--|---|---|---|-----|---|-----|-----|----|---|---|--|--|--|---|---|---|-----|---|-----|-----|----|---|--|---|--|--|---|---|---|-----|---|-----|-----|----|---|---|---|--|--|---|---|---|-----|---|-----|-----|----|---|--|--|---|--|---|---|---|-----|---|-----|-----|----|---|---|--|---|--|---|---|---|-----|---|-----|-----|----|---|--|---|---|--|---|---|---|-----|---|-----|-----|----|---|---|---|---|--|---|---|---|-----|---|-----|-----|----|---|--|--|--|---|---|---|---|-----|---|-----|-----|----|---|---|--|--|---|---|---|---|-----|---|
| | 336 | 21 | 16 | | | | | 5 | 7 | 9 | --- | / | DCC | 337 | 22 | 1 | 1 | | | | 5 | 7 | 9 | --- | / | DCC | 338 | 22 | 2 | | 2 | | | 5 | 7 | 9 | --- | / | DCC | 339 | 22 | 3 | 1 | 2 | | | 5 | 7 | 9 | --- | / | DCC | 340 | 22 | 4 | | | 3 | | 5 | 7 | 9 | --- | / | DCC | 341 | 22 | 5 | 1 | | 3 | | 5 | 7 | 9 | --- | / | DCC | 342 | 22 | 6 | | 2 | 3 | | 5 | 7 | 9 | --- | / | DCC | 343 | 22 | 7 | 1 | 2 | 3 | | 5 | 7 | 9 | --- | / | DCC | 344 | 22 | 8 | | | | 4 | 5 | 7 | 9 | --- | / | DCC | 345 | 22 | 9 | 1 | | | | 4 | 5 | 7 | 9 | --- | / | DCC | 346 | 22 | 10 | | 2 | | | 4 | 5 | 7 | 9 | --- | / | DCC | 347 | 22 | 11 | 1 | 2 | | | 4 | 5 | 7 | 9 | --- | / | DCC | 348 | 22 | 12 | | | 3 | 4 | 5 | 7 | 9 | --- | / | DCC | 349 | 22 | 13 | 1 | | 3 | 4 | 5 | 7 | 9 | --- | / | DCC | 350 | 22 | 14 | | 2 | 3 | 4 | 5 | 7 | 9 | --- | / | DCC | 351 | 22 | 15 | 1 | 2 | 3 | 4 | 5 | 7 | 9 | --- | / | DCC | 352 | 22 | 16 | | | | | 6 | 7 | 9 | --- | / | DCC | 353 | 23 | 1 | 1 | | | | 6 | 7 | 9 | --- | / | DCC | 354 | 23 | 2 | | 2 | | | 6 | 7 | 9 | --- | / | DCC | 355 | 23 | 3 | 1 | 2 | | | 6 | 7 | 9 | --- | / | DCC | 356 | 23 | 4 | | | 3 | | 6 | 7 | 9 | --- | / | DCC | 357 | 23 | 5 | 1 | | 3 | | 6 | 7 | 9 | --- | / | DCC | 358 | 23 | 6 | | 2 | 3 | | 6 | 7 | 9 | --- | / | DCC | 359 | 23 | 7 | 1 | 2 | 3 | | 6 | 7 | 9 | --- | / | DCC | 360 | 23 | 8 | | | | 4 | 6 | 7 | 9 | --- | / | DCC | 361 | 23 | 9 | 1 | | | 4 | 6 | 7 | 9 | --- | / |



|  |  | | | | | | | | | |  | | | | | | | | | | 10 (0/1) | | | | | | | | | | | | | | | | | | | | | | | | | | | | | | | | | | | | | | | | | | | | | | | | | | | | | | | | | | | | | | | | | | | | | | | | | | | | | | | | | | | | | | | | | | | | | | | | | | | | | | | | | | | | | | | | | | | | | | | | | | | | | | | | | | | | | | | | | | | | | | | | | | | | | | | | | | | | | | | | | | | | | | | | | | | | | | | | | | | | | | | | | | | | | | | | | | | | | | | | | | | | | | | | | | | | | | | | | | | | | | | | | | | | | | | | | | | | | | | | | | | | | | | | | | | | | | | | | | | | | | | | | | | | | | | | | | | | | | | | | | | | | | | | | | | | | | | | | | | | | | | | | | | | | | | | | | | | | | | | | | | | | | | | | | | | | | | | | | | | | | | |
|--|--|----|----|--|--|--|--|---|---|---|--|---|-----|---|-----|-----|----|----|---|---|----------|--|---|---|---|---|-----|---|-----|-----|----|----|--|--|---|---|---|---|---|-----|---|-----|-----|----|----|---|--|---|---|---|---|---|-----|---|-----|-----|----|----|--|---|---|---|---|---|---|-----|---|-----|-----|----|----|---|---|---|---|---|---|---|-----|---|-----|-----|----|----|--|--|--|--|---|---|---|---|-----|---|-----|-----|----|---|---|--|--|--|---|---|---|---|-----|---|-----|-----|----|---|--|---|--|--|---|---|---|---|-----|---|-----|-----|----|---|---|---|--|--|---|---|---|---|-----|---|-----|-----|----|---|--|--|---|--|---|---|---|---|-----|---|-----|-----|----|---|---|--|---|--|---|---|---|---|-----|---|-----|-----|----|---|--|---|---|--|---|---|---|---|-----|---|-----|-----|----|---|---|---|---|--|---|---|---|---|-----|---|-----|-----|----|---|--|--|--|---|---|---|---|---|-----|---|-----|-----|----|---|---|--|--|---|---|---|---|---|-----|---|-----|-----|----|----|--|---|--|---|---|---|---|---|-----|---|-----|-----|----|----|---|---|--|---|---|---|---|---|-----|---|-----|-----|----|----|--|--|---|---|---|---|---|---|-----|---|-----|-----|----|----|---|--|---|---|---|---|---|---|-----|---|-----|-----|----|----|--|---|---|---|---|---|---|---|-----|---|-----|-----|----|----|---|---|---|---|---|---|---|---|-----|---|-----|-----|----|----|--|--|--|--|--|--|--|---|---|-----|---|-----|-----|----|---|---|--|--|--|--|--|--|---|---|-----|---|-----|-----|----|---|--|---|--|--|--|--|--|---|---|-----|---|-----|-----|----|---|---|---|--|--|--|--|--|---|---|-----|---|
| | 362 | 23 | 10 | | | | | 2 | 4 | 6 | 7 | 9 | --- | / | DCC | 363 | 23 | 11 | 1 | 2 | | | 4 | 6 | 7 | 9 | --- | / | DCC | 364 | 23 | 12 | | | 3 | 4 | 6 | 7 | 9 | --- | / | DCC | 365 | 23 | 13 | 1 | | 3 | 4 | 6 | 7 | 9 | --- | / | DCC | 366 | 23 | 14 | | 2 | 3 | 4 | 6 | 7 | 9 | --- | / | DCC | 367 | 23 | 15 | 1 | 2 | 3 | 4 | 6 | 7 | 9 | --- | / | DCC | 368 | 23 | 16 | | | | | 5 | 6 | 7 | 9 | --- | / | DCC | 369 | 24 | 1 | 1 | | | | 5 | 6 | 7 | 9 | --- | / | DCC | 370 | 24 | 2 | | 2 | | | 5 | 6 | 7 | 9 | --- | / | DCC | 371 | 24 | 3 | 1 | 2 | | | 5 | 6 | 7 | 9 | --- | / | DCC | 372 | 24 | 4 | | | 3 | | 5 | 6 | 7 | 9 | --- | / | DCC | 373 | 24 | 5 | 1 | | 3 | | 5 | 6 | 7 | 9 | --- | / | DCC | 374 | 24 | 6 | | 2 | 3 | | 5 | 6 | 7 | 9 | --- | / | DCC | 375 | 24 | 7 | 1 | 2 | 3 | | 5 | 6 | 7 | 9 | --- | / | DCC | 376 | 24 | 8 | | | | 4 | 5 | 6 | 7 | 9 | --- | / | DCC | 377 | 24 | 9 | 1 | | | 4 | 5 | 6 | 7 | 9 | --- | / | DCC | 378 | 24 | 10 | | 2 | | 4 | 5 | 6 | 7 | 9 | --- | / | DCC | 379 | 24 | 11 | 1 | 2 | | 4 | 5 | 6 | 7 | 9 | --- | / | DCC | 380 | 24 | 12 | | | 3 | 4 | 5 | 6 | 7 | 9 | --- | / | DCC | 381 | 24 | 13 | 1 | | 3 | 4 | 5 | 6 | 7 | 9 | --- | / | DCC | 382 | 24 | 14 | | 2 | 3 | 4 | 5 | 6 | 7 | 9 | --- | / | DCC | 383 | 24 | 15 | 1 | 2 | 3 | 4 | 5 | 6 | 7 | 9 | --- | / | DCC | 384 | 24 | 16 | | | | | | | | 8 | 9 | --- | / | DCC | 385 | 25 | 1 | 1 | | | | | | | 8 | 9 | --- | / | DCC | 386 | 25 | 2 | | 2 | | | | | | 8 | 9 | --- | / | DCC | 387 | 25 | 3 | 1 | 2 | | | | | | 8 | 9 | --- | / |

| |  |  | | | | | | | | | | | |
|-----|--|--|---|---|---|---|---|--|--|---|---|-----|------|
| | | 10 (0/1) | | | | | | | | | | | |
| 388 | 25 | 4 | | | 3 | | | | | 8 | 9 | --- | /DCC |
| 389 | 25 | 5 | 1 | | 3 | | | | | 8 | 9 | --- | /DCC |
| 390 | 25 | 6 | | 2 | 3 | | | | | 8 | 9 | --- | /DCC |
| 391 | 25 | 7 | 1 | 2 | 3 | | | | | 8 | 9 | --- | /DCC |
| 392 | 25 | 8 | | | | 4 | | | | 8 | 9 | --- | /DCC |
| 393 | 25 | 9 | 1 | | | 4 | | | | 8 | 9 | --- | /DCC |
| 394 | 25 | 10 | | 2 | | 4 | | | | 8 | 9 | --- | /DCC |
| 395 | 25 | 11 | 1 | 2 | | 4 | | | | 8 | 9 | --- | /DCC |
| 396 | 25 | 12 | | | 3 | 4 | | | | 8 | 9 | --- | /DCC |
| 397 | 25 | 13 | 1 | | 3 | 4 | | | | 8 | 9 | --- | /DCC |
| 398 | 25 | 14 | | 2 | 3 | 4 | | | | 8 | 9 | --- | /DCC |
| 399 | 25 | 15 | 1 | 2 | 3 | 4 | | | | 8 | 9 | --- | /DCC |
| 400 | 25 | 16 | | | | | 5 | | | 8 | 9 | --- | /DCC |
| 401 | 26 | 1 | 1 | | | | 5 | | | 8 | 9 | --- | /DCC |
| 402 | 26 | 2 | | 2 | | | 5 | | | 8 | 9 | --- | /DCC |
| 403 | 26 | 3 | 1 | 2 | | | 5 | | | 8 | 9 | --- | /DCC |
| 404 | 26 | 4 | | | 3 | | 5 | | | 8 | 9 | --- | /DCC |
| 405 | 26 | 5 | 1 | | 3 | | 5 | | | 8 | 9 | --- | /DCC |
| 406 | 26 | 6 | | 2 | 3 | | 5 | | | 8 | 9 | --- | /DCC |
| 407 | 26 | 7 | 1 | 2 | 3 | | 5 | | | 8 | 9 | --- | /DCC |
| 408 | 26 | 8 | | | | 4 | 5 | | | 8 | 9 | --- | /DCC |
| 409 | 26 | 9 | 1 | | | 4 | 5 | | | 8 | 9 | --- | /DCC |
| 410 | 26 | 10 | | 2 | | 4 | 5 | | | 8 | 9 | --- | /DCC |
| 411 | 26 | 11 | 1 | 2 | | 4 | 5 | | | 8 | 9 | --- | /DCC |
| 412 | 26 | 12 | | | 3 | 4 | 5 | | | 8 | 9 | --- | /DCC |
| 413 | 26 | 13 | 1 | | 3 | 4 | 5 | | | 8 | 9 | --- | /DCC |

| |  |  | | | | | | | | | | | | |
|-----|--|--|---|---|---|---|---|---|--|---|---|-----|------|------|
| | | 10 (0/1) | | | | | | | | | | | | |
| 414 | 26 | 14 | | | 2 | 3 | 4 | 5 | | | 8 | 9 | --- | /DCC |
| 415 | 26 | 15 | 1 | 2 | 3 | 4 | 5 | | | 8 | 9 | --- | /DCC | |
| 416 | 26 | 16 | | | | | | 6 | | 8 | 9 | --- | /DCC | |
| 417 | 27 | 1 | 1 | | | | | 6 | | 8 | 9 | --- | /DCC | |
| 418 | 27 | 2 | | 2 | | | | 6 | | 8 | 9 | --- | /DCC | |
| 419 | 27 | 3 | 1 | 2 | | | | 6 | | 8 | 9 | --- | /DCC | |
| 420 | 27 | 4 | | | | 3 | | 6 | | 8 | 9 | --- | /DCC | |
| 421 | 27 | 5 | 1 | | | 3 | | 6 | | 8 | 9 | --- | /DCC | |
| 422 | 27 | 6 | | 2 | 3 | | | 6 | | 8 | 9 | --- | /DCC | |
| 423 | 27 | 7 | 1 | 2 | 3 | | | 6 | | 8 | 9 | --- | /DCC | |
| 424 | 27 | 8 | | | | 4 | | 6 | | 8 | 9 | --- | /DCC | |
| 425 | 27 | 9 | 1 | | | 4 | | 6 | | 8 | 9 | --- | /DCC | |
| 426 | 27 | 10 | | 2 | | 4 | | 6 | | 8 | 9 | --- | /DCC | |
| 427 | 27 | 11 | 1 | 2 | | 4 | | 6 | | 8 | 9 | --- | /DCC | |
| 428 | 27 | 12 | | | 3 | 4 | | 6 | | 8 | 9 | --- | /DCC | |
| 429 | 27 | 13 | 1 | | 3 | 4 | | 6 | | 8 | 9 | --- | /DCC | |
| 430 | 27 | 14 | | 2 | 3 | 4 | | 6 | | 8 | 9 | --- | /DCC | |
| 431 | 27 | 15 | 1 | 2 | 3 | 4 | | 6 | | 8 | 9 | --- | /DCC | |
| 432 | 27 | 16 | | | | | 5 | 6 | | 8 | 9 | --- | /DCC | |
| 433 | 28 | 1 | 1 | | | | 5 | 6 | | 8 | 9 | --- | /DCC | |
| 434 | 28 | 2 | | 2 | | | 5 | 6 | | 8 | 9 | --- | /DCC | |
| 435 | 28 | 3 | 1 | 2 | | | 5 | 6 | | 8 | 9 | --- | /DCC | |
| 436 | 28 | 4 | | | 3 | | 5 | 6 | | 8 | 9 | --- | /DCC | |
| 437 | 28 | 5 | 1 | | 3 | | 5 | 6 | | 8 | 9 | --- | /DCC | |
| 438 | 28 | 6 | | 2 | 3 | | 5 | 6 | | 8 | 9 | --- | /DCC | |
| 439 | 28 | 7 | 1 | 2 | 3 | | 5 | 6 | | 8 | 9 | --- | /DCC | |

| Key | Keyboard | | ON | | | | | | | | | | 10 (0/1) |
|-----|----------|----|----|---|---|---|---|---|---|---|---|-----|----------|
| | 0 | 1 | 1 | 2 | 3 | 4 | 5 | 6 | 7 | 8 | 9 | 0 | |
| 440 | 28 | 8 | | | | 4 | 5 | 6 | | 8 | 9 | --- | /DCC |
| 441 | 28 | 9 | 1 | | | 4 | 5 | 6 | | 8 | 9 | --- | /DCC |
| 442 | 28 | 10 | | 2 | | 4 | 5 | 6 | | 8 | 9 | --- | /DCC |
| 443 | 28 | 11 | 1 | 2 | | 4 | 5 | 6 | | 8 | 9 | --- | /DCC |
| 444 | 28 | 12 | | | 3 | 4 | 5 | 6 | | 8 | 9 | --- | /DCC |
| 445 | 28 | 13 | 1 | | 3 | 4 | 5 | 6 | | 8 | 9 | --- | /DCC |
| 446 | 28 | 14 | | 2 | 3 | 4 | 5 | 6 | | 8 | 9 | --- | /DCC |
| 447 | 28 | 15 | 1 | 2 | 3 | 4 | 5 | 6 | | 8 | 9 | --- | /DCC |
| 448 | 28 | 16 | | | | | | | 7 | 8 | 9 | --- | /DCC |
| 449 | 29 | 1 | 1 | | | | | | 7 | 8 | 9 | --- | /DCC |
| 450 | 29 | 2 | | 2 | | | | | 7 | 8 | 9 | --- | /DCC |
| 451 | 29 | 3 | 1 | 2 | | | | | 7 | 8 | 9 | --- | /DCC |
| 452 | 29 | 4 | | | 3 | | | | 7 | 8 | 9 | --- | /DCC |
| 453 | 29 | 5 | 1 | | 3 | | | | 7 | 8 | 9 | --- | /DCC |
| 454 | 29 | 6 | | 2 | 3 | | | | 7 | 8 | 9 | --- | /DCC |
| 455 | 29 | 7 | 1 | 2 | 3 | | | | 7 | 8 | 9 | --- | /DCC |
| 456 | 29 | 8 | | | | 4 | | | 7 | 8 | 9 | --- | /DCC |
| 457 | 29 | 9 | 1 | | | 4 | | | 7 | 8 | 9 | --- | /DCC |
| 458 | 29 | 10 | | 2 | | 4 | | | 7 | 8 | 9 | --- | /DCC |
| 459 | 29 | 11 | 1 | 2 | | 4 | | | 7 | 8 | 9 | --- | /DCC |
| 460 | 29 | 12 | | | 3 | 4 | | | 7 | 8 | 9 | --- | /DCC |
| 461 | 29 | 13 | 1 | | 3 | 4 | | | 7 | 8 | 9 | --- | /DCC |
| 462 | 29 | 14 | | 2 | 3 | 4 | | | 7 | 8 | 9 | --- | /DCC |
| 463 | 29 | 15 | 1 | 2 | 3 | 4 | | | 7 | 8 | 9 | --- | /DCC |
| 464 | 29 | 16 | | | | | 5 | | 7 | 8 | 9 | --- | /DCC |
| 465 | 30 | 1 | 1 | | | | 5 | | 7 | 8 | 9 | --- | /DCC |

| Key | Keyboard | | ON | | | | | | | | | | 10 (0/1) | |
|-----|----------|----|----|---|---|---|---|---|---|---|---|-----|----------|------|
| | 0 | 1 | 1 | 2 | 3 | 4 | 5 | 6 | 7 | 8 | 9 | 0 | | |
| 466 | 30 | 2 | | 2 | | | | 5 | | 7 | 8 | 9 | --- | /DCC |
| 467 | 30 | 3 | 1 | 2 | | | | 5 | | 7 | 8 | 9 | --- | /DCC |
| 468 | 30 | 4 | | | 3 | | | 5 | | 7 | 8 | 9 | --- | /DCC |
| 469 | 30 | 5 | 1 | | 3 | | | 5 | | 7 | 8 | 9 | --- | /DCC |
| 470 | 30 | 6 | | 2 | 3 | | | 5 | | 7 | 8 | 9 | --- | /DCC |
| 471 | 30 | 7 | 1 | 2 | 3 | | | 5 | | 7 | 8 | 9 | --- | /DCC |
| 472 | 30 | 8 | | | | 4 | 5 | | 7 | 8 | 9 | --- | /DCC | |
| 473 | 30 | 9 | 1 | | | 4 | 5 | | 7 | 8 | 9 | --- | /DCC | |
| 474 | 30 | 10 | | 2 | | 4 | 5 | | 7 | 8 | 9 | --- | /DCC | |
| 475 | 30 | 11 | 1 | 2 | | 4 | 5 | | 7 | 8 | 9 | --- | /DCC | |
| 476 | 30 | 12 | | | 3 | 4 | 5 | | 7 | 8 | 9 | --- | /DCC | |
| 477 | 30 | 13 | 1 | | 3 | 4 | 5 | | 7 | 8 | 9 | --- | /DCC | |
| 478 | 30 | 14 | | 2 | 3 | 4 | 5 | | 7 | 8 | 9 | --- | /DCC | |
| 479 | 30 | 15 | 1 | 2 | 3 | 4 | 5 | | 7 | 8 | 9 | --- | /DCC | |
| 480 | 30 | 16 | | | | | | 6 | 7 | 8 | 9 | --- | /DCC | |
| 481 | 31 | 1 | 1 | | | | | 6 | 7 | 8 | 9 | --- | /DCC | |
| 482 | 31 | 2 | | 2 | | | | 6 | 7 | 8 | 9 | --- | /DCC | |
| 483 | 31 | 3 | 1 | 2 | | | | 6 | 7 | 8 | 9 | --- | /DCC | |
| 484 | 31 | 4 | | | 3 | | | 6 | 7 | 8 | 9 | --- | /DCC | |
| 485 | 31 | 5 | 1 | | 3 | | | 6 | 7 | 8 | 9 | --- | /DCC | |
| 486 | 31 | 6 | | 2 | 3 | | | 6 | 7 | 8 | 9 | --- | /DCC | |
| 487 | 31 | 7 | 1 | 2 | 3 | | | 6 | 7 | 8 | 9 | --- | /DCC | |
| 488 | 31 | 8 | | | | 4 | | 6 | 7 | 8 | 9 | --- | /DCC | |
| 489 | 31 | 9 | 1 | | | 4 | | 6 | 7 | 8 | 9 | --- | /DCC | |
| 490 | 31 | 10 | | 2 | | 4 | | 6 | 7 | 8 | 9 | --- | /DCC | |
| 491 | 31 | 11 | 1 | 2 | | 4 | | 6 | 7 | 8 | 9 | --- | /DCC | |

| |  |  | | | | | | | | | | | | |
|-----|--|--|---|---|---|---|--|---|---|---|---|-----|------|------|
| | | 10 (0/1) | | | | | | | | | | | | |
| 492 | 31 | 12 | | | 3 | 4 | | 6 | 7 | 8 | 9 | --- | /DCC | |
| 493 | 31 | 13 | 1 | | 3 | 4 | | 6 | 7 | 8 | 9 | --- | /DCC | |
| 494 | 31 | 14 | | 2 | 3 | 4 | | 6 | 7 | 8 | 9 | --- | /DCC | |
| 495 | 31 | 15 | 1 | 2 | 3 | 4 | | 6 | 7 | 8 | 9 | --- | /DCC | |
| 496 | 31 | 16 | | | | | | 5 | 6 | 7 | 8 | 9 | --- | /DCC |
| 497 | 32 | 1 | 1 | | | | | 5 | 6 | 7 | 8 | 9 | --- | /DCC |
| 498 | 32 | 2 | | 2 | | | | 5 | 6 | 7 | 8 | 9 | --- | /DCC |
| 499 | 32 | 3 | 1 | 2 | | | | 5 | 6 | 7 | 8 | 9 | --- | /DCC |
| 500 | 32 | 4 | | | 3 | | | 5 | 6 | 7 | 8 | 9 | --- | /DCC |
| 501 | 32 | 5 | 1 | | 3 | | | 5 | 6 | 7 | 8 | 9 | --- | /DCC |
| 502 | 32 | 6 | | 2 | 3 | | | 5 | 6 | 7 | 8 | 9 | --- | /DCC |
| 503 | 32 | 7 | 1 | 2 | 3 | | | 5 | 6 | 7 | 8 | 9 | --- | /DCC |
| 504 | 32 | 8 | | | | 4 | | 5 | 6 | 7 | 8 | 9 | --- | /DCC |
| 505 | 32 | 9 | 1 | | | 4 | | 5 | 6 | 7 | 8 | 9 | --- | /DCC |
| 506 | 32 | 10 | | 2 | | 4 | | 5 | 6 | 7 | 8 | 9 | --- | /DCC |
| 507 | 32 | 11 | 1 | 2 | | 4 | | 5 | 6 | 7 | 8 | 9 | --- | /DCC |
| 508 | 32 | 12 | | | 3 | 4 | | 5 | 6 | 7 | 8 | 9 | --- | /DCC |
| 509 | 32 | 13 | 1 | | 3 | 4 | | 5 | 6 | 7 | 8 | 9 | --- | /DCC |
| 510 | 32 | 14 | | 2 | 3 | 4 | | 5 | 6 | 7 | 8 | 9 | --- | /DCC |
| 511 | 32 | 15 | 1 | 2 | 3 | 4 | | 5 | 6 | 7 | 8 | 9 | --- | /DCC |

Adressen größer 511 können nur im DCC Format ausgegeben werden und müssen mit der CV Programmierung über das Programmiergleis durchgeführt werden.

Addresses larger than 511 can only be assigned in the DCC format and must be done by programming a CV using the programming track.

Les adresses supérieures à 511 peuvent uniquement être éditées dans le format DCC et doivent être exécutées avec la programmation des CV via la voie de programmation.

Adressen groter dan 511 kunnen alleen in het DCC formaat gebruikt worden en moeten met de CV programmering via het programmeerspoor ingesteld worden.

Las direcciones superiores a 511 pueden mostrarse en el formato DCC y deben configurarse con la función Programación de CVs mediante la vía de programación.

Indirizzi maggiori di 511 possono essere assegnati solo nel formato DCC e si devono eseguire con la programmazione delle CV tramite il binario di programmazione.

Adresser överstigande 511 kan endast skrivas in i DCC-format och måste göras med CV-programmering med loket på programmeringspåret.

Adresser højere end 511 kan kun udtrykkes i DCC format og skal udføres med CV programmeringen via programmeringsporet.

Aufbau • Setup • Montage • Opbouwen • Montaje • Montaggio • Montering • Forsamling

Kabelfarben Colors for the Wires Couleurs des câbles Draadkleuren Colores de los cables Colori dei cavetti Kabelfärgerna Kabelfarverne

- 1 rot / red / rouge / rood /
rojo / rosso / röd / rød
- 2 braun / brown / brun / bruin /
marrón / marrone / brun / brun
- 3 gelb / yellow / jaune / geel /
amarillo / giallo / gul / gul
- 4 violett / violett / violet / paars /
violeta / viola / violett / violet
- 5 rot-braun / red-brown / rouge-brun / rood-bruin /
rojo-marrón / rosso-marrone / röd-brun / rød-brun
- 6 rot-grün / red-green / rouge-vert / rood-grøen /
rojo-verde / rosso-verde / röd-grön / rød-grøn

Anschluss Programmiergleis
Connections for the Programming Track
Branchement voie de programmation
Aansluiten op het programmeerspoor
Conexión de la vía de programación
Collegamento del binario di programmazione
Anslutning till programmeringsspåret
Tilslutning programmeringsskinne

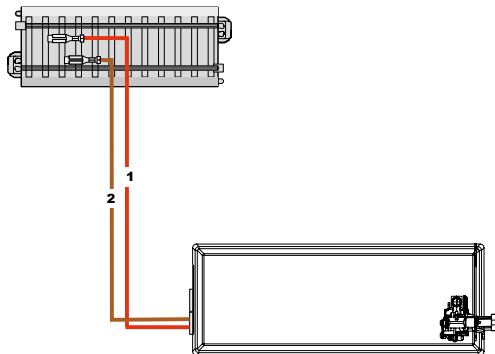

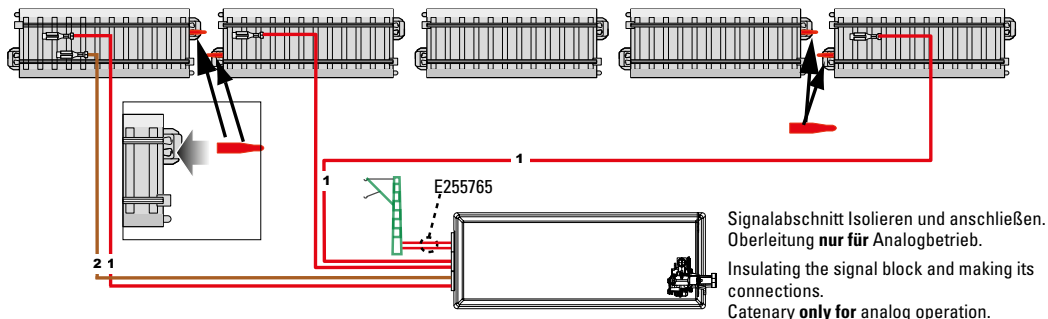

Signalabschnitt Isolieren und anschließen.
Oberleitung **nur für** Analogbetrieb.

Insulating the signal block and making its connections.

Catenary **only** for analog operation.

Isoler la partie du signal et brancher.

Caténaires **seulement pour** exploitation analogique.

Stopsectie isoleren en aansluiten.

Bovenleiding **alleen in** analoogbedrijf.

Aislamiento y conexión del tramo de señal.

Corriente por catenaria **solo modo** analógico.

Isolamento e connessioni della tratta del segnale.

Catenaria **solo per la** modalità analogica.

Isolering av och anslutning av ett spåravsnitt.

Kontaktledning **bara för** analogt läge.

Isolér og tilslut signalafsnit.

Køreledninger **kun for** analog tilstand.

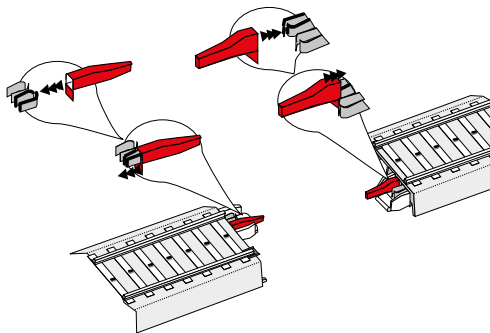

Befestigung am C-Gleis
Installation with C Track
Fixation à la voie C
Bevestiging aan C-rail
Sujeción a la vía C
Fissaggio al binario C
Fastsättning vid C-räls
Fastgørelse på C-skinne

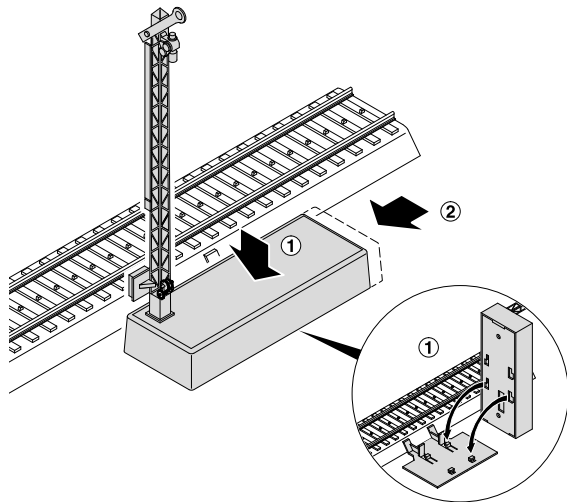
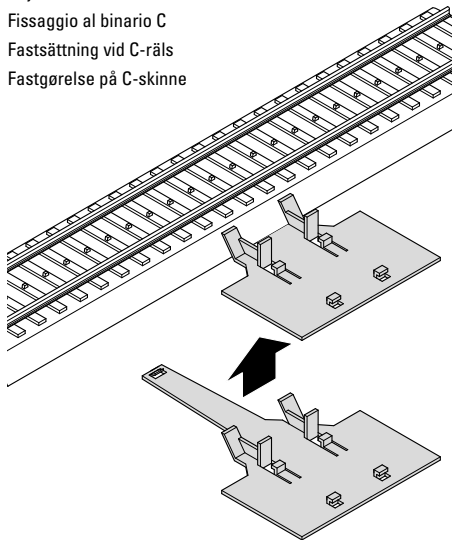

Befestigung am K-Gleis oder anderen Gleissystemen
Installation with K Track or Other Track Systems
Fixation à la voie K ou à d'autres systèmes de voies
Befestiging aan K-rail of ander railsysteem
Sujeción a la vía K u a otros sistemas de vías
Fissaggio al binario K oppure altri sistemi di binario
Fastsättning vid K-räls eller andra rälsystem
Fastgørelse på K-skinne eller andre skinneresystemer

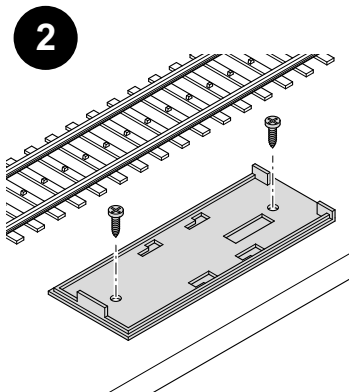
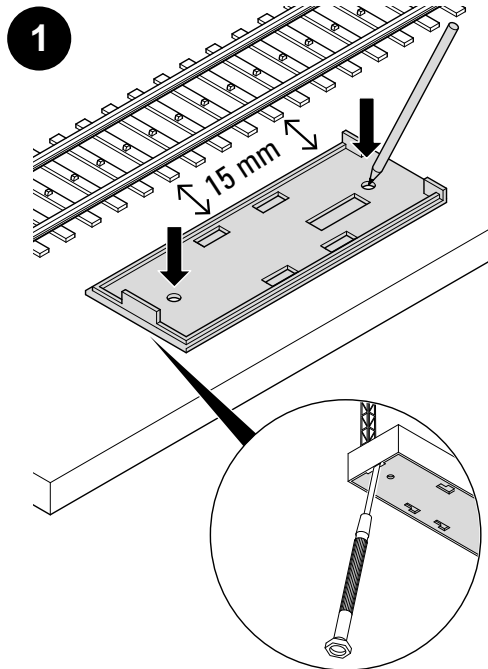

Mit beiliegender Bohrschablone markieren (Unterflurmontage).
Mark with the template included with the signal (Below-Baseboard Installation).
Marquer avec le patron de perçage ci-joint (Montage souterrain).
Met meegeleverde sjabloon markeren (Ondervloermontage).
Marcar con la plantilla de taladros adjunta (Montaje bajo el suelo).
Marcare con l'acclusa maschera di foratura (Montaggio sotto plancia).
Markera med hjälp av medföljande borrhäblon (Montage under anläggningen).
Markér med vedlagte boreskabelon (Underhængt montering).

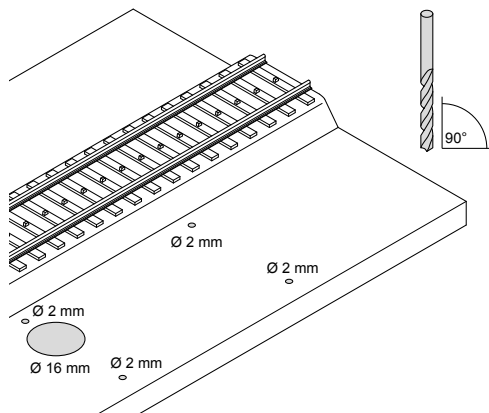
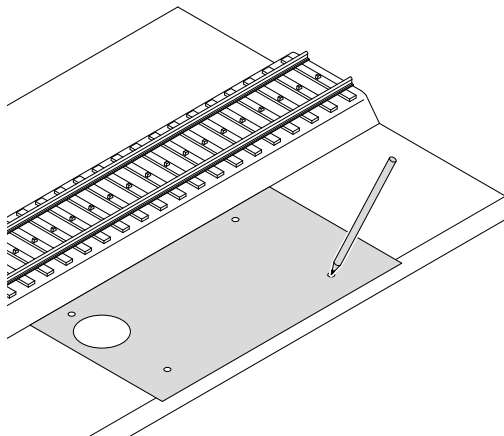

Steckteile entfernen

Remove detail parts.

Ôter les connecteurs

Opsteekdelen verwijderen

Desmontaje de las piezas enchufables

Rimuovere gli elementi a innesto

Avl agsna insticksdelar

Fjern stikdele

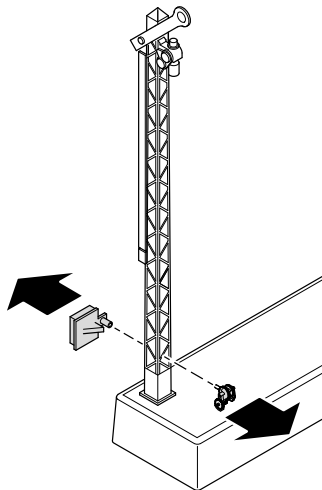

Unterflurmontage:

Below-Baseboard Installation:

Montage souterrain :

Ondervloermontage:

Montaje bajo el suelo:

Montaggio sotto plancia:

Montage under anläggningen:

Underhængt montering:

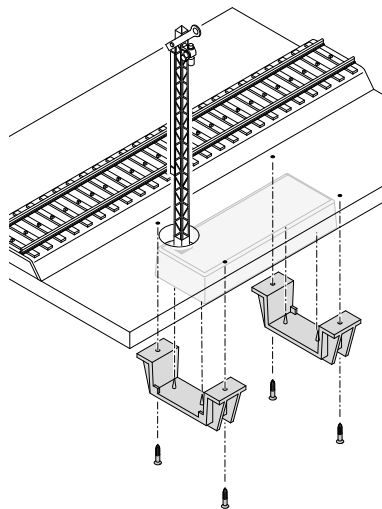
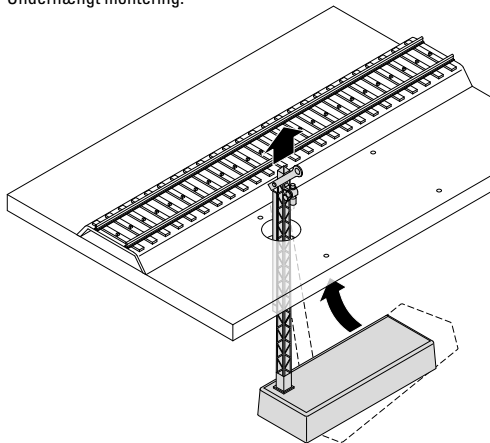

Abdeckung anbringen

Install the cover

Poser le couvercle

Afdekking aanbrengen

Colocar la cubierta

Applicare il coperchio

Sätt på locket

Anbring afdækning

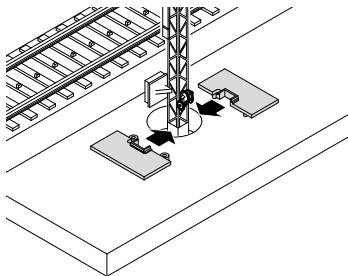

Steckteile nach erfolgter Unterflurmontage wieder anbringen.

Reinstall detail parts after completing below-baseboard installation.

Remonter les connecteurs après le montage souterrain.

Opsteekdelen na succesvolle ondervloermontage weer aanbrengen.

Colocar de nuevo las piezas enchufables una vez realizado el montaje bajo el suelo.

Applicare di nuovo gli elementi a innesto dopo avvenuto montaggio sotto plancia.

Efter montage av signalen under anläggningen sätts insticksdelarna tillbaka.

Anbring stikdele efter gennemført underhængt montering.

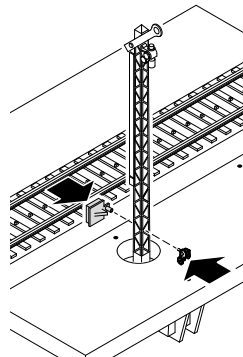

**Aufkleber anbringen • Attach decals • Fixez les autocollants • Bevestig stickers •
 Allega decalcomanie • Coloque las calcomanías • Bifoga dekaler • Vedhæft decals**

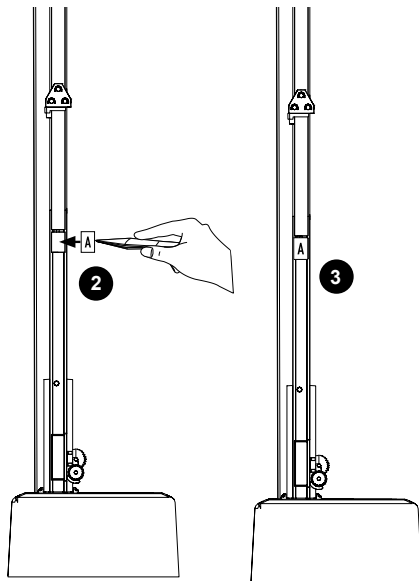
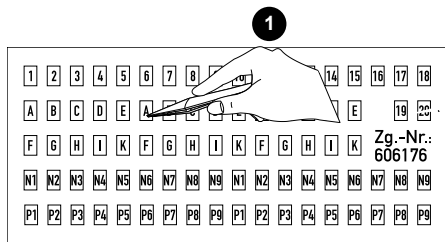

**Bohrschablone • Drilling Template • Gabarit de perçage • Boorsjabloon •
Plantilla • Maschera di Foratura • Borrschablon • Boreskabelon**

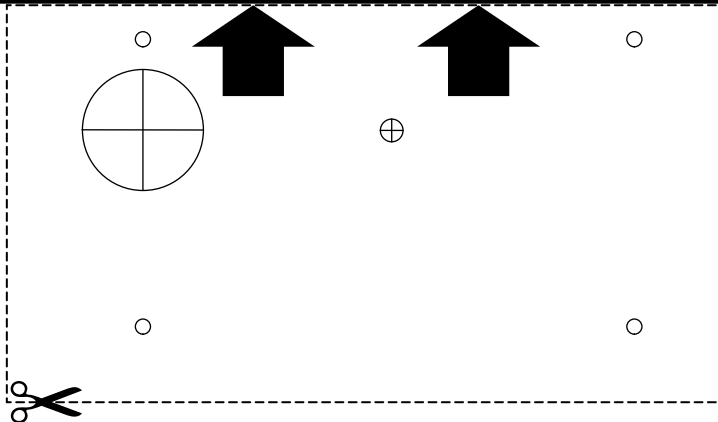
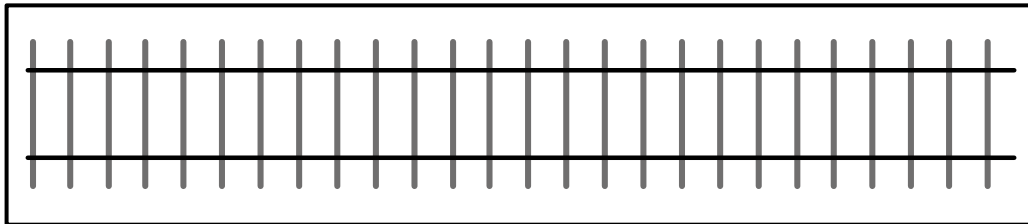

Gebr. Märklin & Cie. GmbH
Stuttgarter Straße 55 - 57
73033 Göppingen
Germany
www.maerklin.com

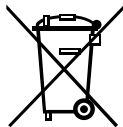

www.maerklin.com/en/imprint.html

296063/0520/Sc3Pw
Änderungen vorbehalten
© Gebr. Märklin & Cie. GmbH