

672 267 TIALD pod

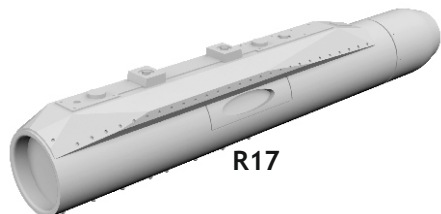

1/72 scale



R17



R18



R19

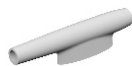

R20

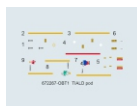

COLOURS

GSI Creos (GUNZE)		Mr.METAL COLOR
AQUEOUS	Mr.COLOR	
H 2	C 2	BLACK
H 18	C 28	STEEL
H 44	C 51	FLESH
H310	C310	BROWN

672 267

TIALD pod

1/72

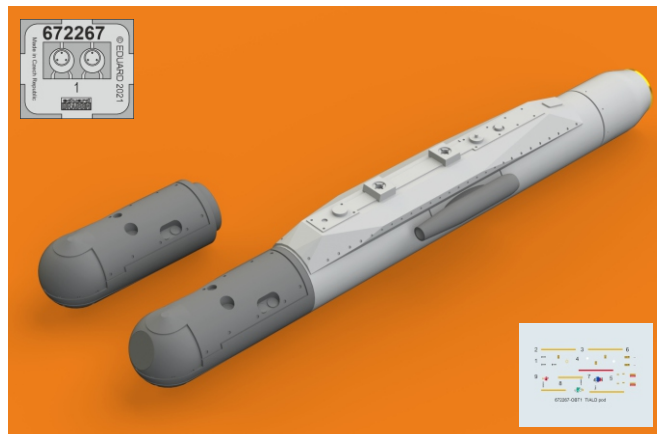

435 21 Obrnice 170
Czech Republic

www.eduard.com
9,95



DECALS

TOP VIEW

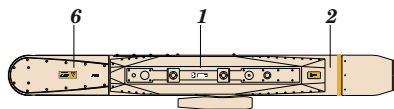

SIDE VIEW

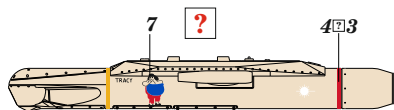
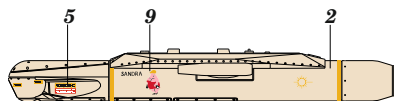

R19

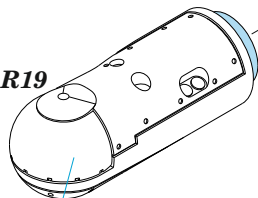

DESERT SAND $\frac{10\%}{\text{H310}} + \frac{90\%}{\text{C310}}$ + $\frac{10\%}{\text{H44}} + \frac{90\%}{\text{C51}}$



R18

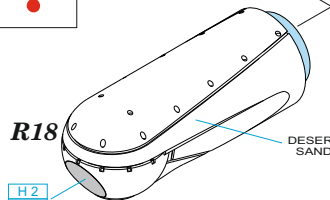

$\frac{\text{H2}}{\text{C2}}$
BLACK

DESERT SAND $\frac{10\%}{\text{H310}} + \frac{90\%}{\text{C310}}$ + $\frac{10\%}{\text{H44}} + \frac{90\%}{\text{C51}}$

DESERT SAND $\frac{10\%}{\text{H310}} + \frac{90\%}{\text{C310}}$ + $\frac{10\%}{\text{H44}} + \frac{90\%}{\text{C51}}$

DESERT SAND $\frac{10\%}{\text{H310}} + \frac{90\%}{\text{C310}}$ + $\frac{10\%}{\text{H44}} + \frac{90\%}{\text{C51}}$

PE1



R20

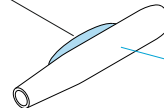

DESERT SAND $\frac{10\%}{\text{H310}} + \frac{90\%}{\text{C310}}$ + $\frac{10\%}{\text{H44}} + \frac{90\%}{\text{C51}}$

$\frac{\text{H18}}{\text{C28}}$
STEEL

R17

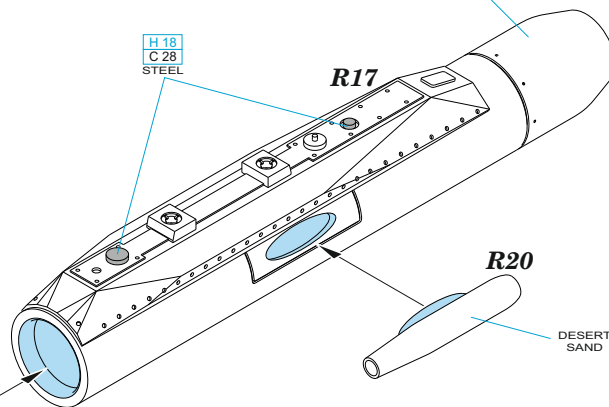

- | | |
|---|---------------------|
| REMOVE
ODSTRANIT | BEND
OHNOUT |
| GRIND
OBROUSIT | OPTION
VOLBA |
| DRILL HOLE
VRTAT OTVOR | REPLACE
NAHRADIT |
| SYMMETRICAL ASSEMBLY
SYMETRICKÁ MONTÁŽ | |
| SCRIBE THE PANEL AND HOLES
RYTI | |
| REVERSE SIDE
OTOČIT | |