

648 641 RP-3 60lb rockets for Tempest Mk.II

for Eduard / Special Hobby kit -
pro stavebnici Eduard / Special Hobby

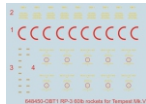

1/48 scale

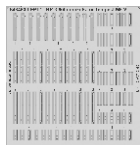
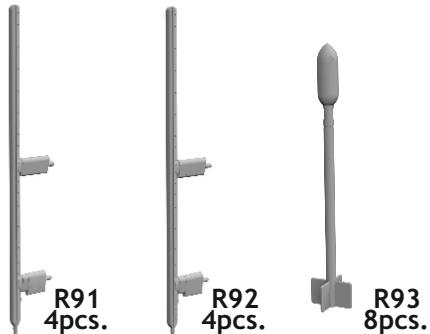

COLOURS

GSI Creos (GUNZE)			GSI Creos (GUNZE)		
AQUEOUS	Mr.COLOR		AQUEOUS	Mr.COLOR	
H 4	C 4	YELLOW	H316	C316	WHITE
H 8	C 8	SILVER	H335	C363	SEAGRAY
H27	C44	TAN		C 78	METAL BLACK
H52	C12	OLIVE DRAB			

This product contains metal and resin detail parts for upgrading scale plastic models. When selecting this set make sure that it is for the kit mentioned in product name as these sets are made specifically for that kit. When upgrading the model some cutting or corrections may be necessary for parts to fit accurately. **WARNING!** This set contains small and sharp parts. Work carefully in a ventilated and well-lit room. Safety glasses are recommended. This product is not suitable for children below 14 years of age.

Tento výrobek obsahuje leptané a odlévané detaily pro úpravu a vylepšení plastického modelu. Při výběru sady kovových detailů zkontrolujte, zda je určena pro model, který chcete upravit. Model, pro který je sada určena, je uveden u názvu výrobku. Pro přesnou aplikaci kovových a odlévaných dílů může být zapotřebí upravit díly upravovaného modelu. **POZOR!** Sada obsahuje malé ostré díly. Pracujte ve větrané a dobře osvětlené místnosti. Doporučujeme použití ochranných brýlí. Tento výrobek není vhodný pro děti mladší 14 let.



435 21 Obrnice 170
Czech Republic

www.eduard.com

12,95



648 641 RP-3 60lb rockets for Tempest Mk.II

for Eduard / Special Hobby kit - pro stavebnici Eduard / Special Hobby

1/48

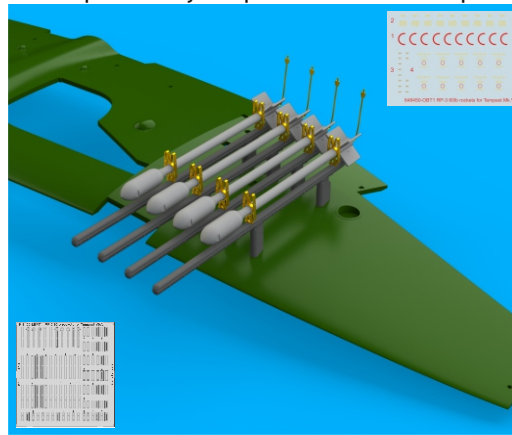

RP-3 60lb rockets for Tempest Mk.II

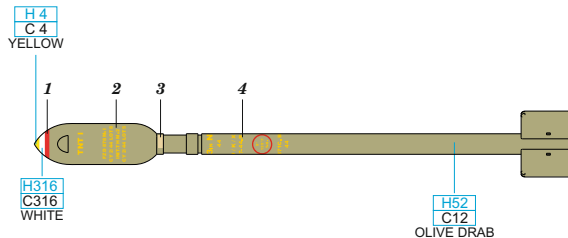

BEST BRASS RESIN AROUND!







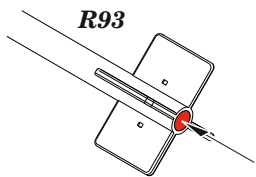





= 

8 pcs.



R93



Ø - 1mm
l - 1mm

-  REMOVE ODSTRANIT
-  BEND OHNOUT
-  GRIND OBROUSIT
-  OPTION VOLBA
-  DRILL HOLE VRTAT OTVOR
-  REPLACE NAHRADIT
-  SYMMETRICAL ASSEMBLY SYMETRICKÁ MONTÁŽ
-  SCRIBE THE PANEL AND HOLES RYTI
-  REVERSE SIDE OTOČIT

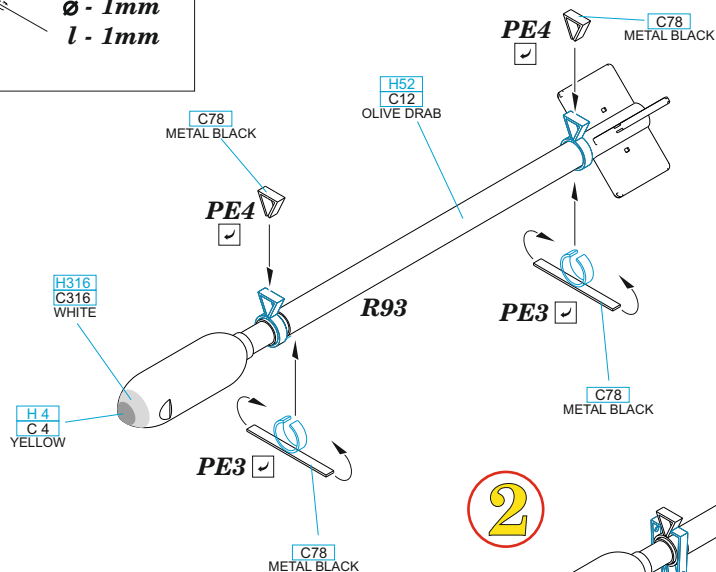
1

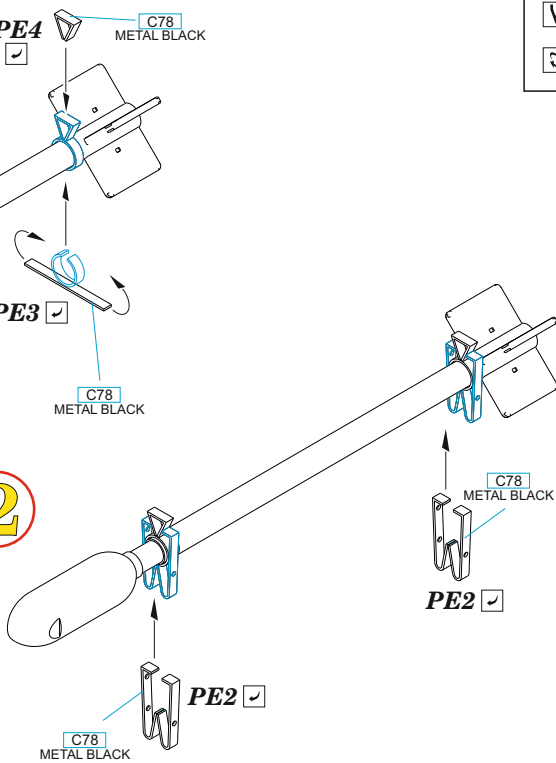

2



3

H27
C44
TAN

PE1

4

R91 R92

H 8
C 8
SILVER

H335
C363
SEAGRAY

CORRECT POSITION FOR R93

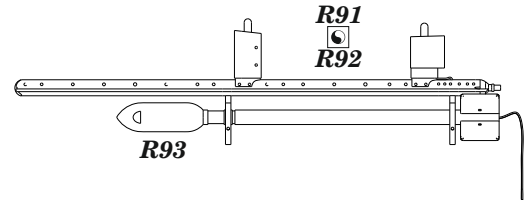

**R91-LEFT SIDE
R92-RIGHT SIDE**

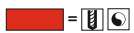

∅ - 0,9mm

plastic part

5

R92  R91
4pcs. 4pcs.

plastic part