

# 648 453 PAVE Way I Mk.83 Hi Speed LGB Non-Thermally Protected

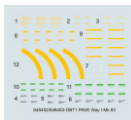

1/48 scale

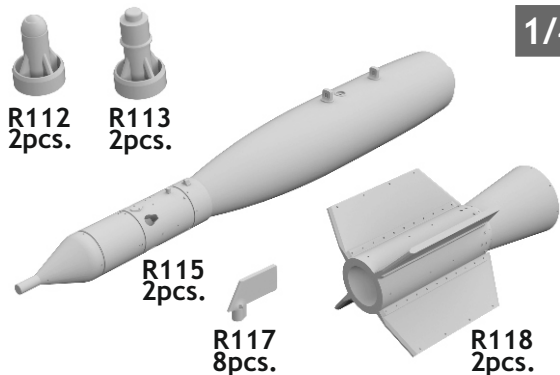

## COLOURS

GSI Creos (GUNZE)		Mr.METAL COLOR	
AQUEOUS	Mr.COLOR		
[H 8]	[C 8]	SILVER	
[H12]	[C33]	FLAT BLACK	
[H27]	[C44]	TAN	
[H52]	[C12]	OLIVE DRAB	

This product contains metal and resin detail parts for upgrading scale plastic models. When selecting this set make sure that it is for the kit mentioned in product name as these sets are made specifically for that kit. When upgrading the model some cutting or corrections may be necessary for parts to fit accurately. **WARNING!** This set contains small and sharp parts. Work carefully in a ventilated and well-lit room. Safety glasses are recommended. This product is not suitable for children below 14 years of age.

Tento výrobek obsahuje leptané a odlévané detaily pro úpravu a vylepšení plastického modelu. Při výběru sady kovových detailů zkontrolujte, zda je určena pro model, který chcete upravit. Model, pro který je sada určena, je uveden u názvu výrobku. Pro přesnou aplikaci kovových a odlévaných dílů může být zapotřebí upravit díly upravovaného modelu. **POZOR!** Sada obsahuje malé ostré díly. Pracujte ve větrané a dobře osvětlené místnosti. Doporučujeme použití ochranných brýlí. Tento výrobek není vhodný pro děti mladší 14 let.



435 21 Obrnice 170  
Czech Republic

www.eduard.com

14,95



# 648 453 PAVE Way I Mk.83 Hi Speed 1/48 LGB Non-Thermally Protected

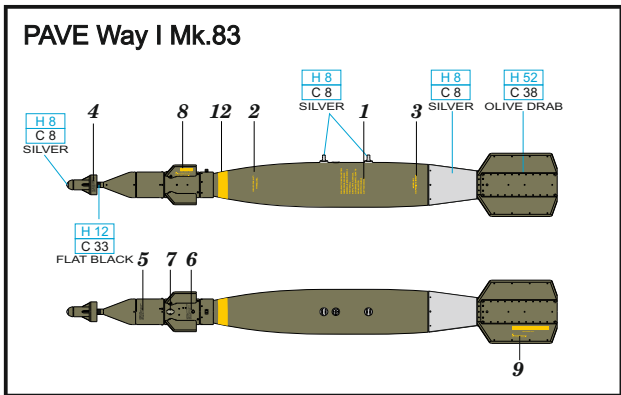
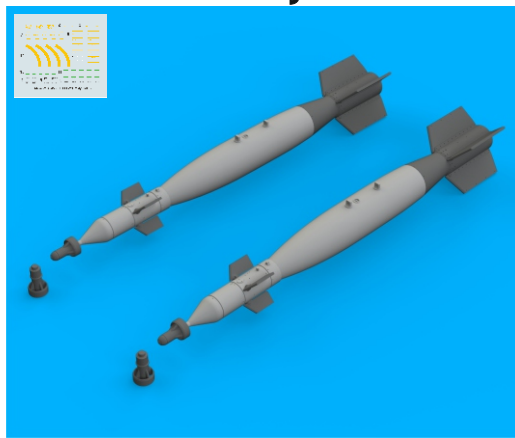

**BEST BRASS RESIN AROUND!**

 = 

∅ - 0,9mm  
l - 1,5mm

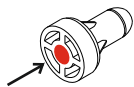



R112

?







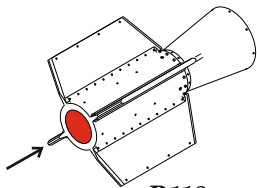



R113

 =  ∅ - 3,5mm  
l - 5mm



R118

-  REMOVE  
ODSTRANIT
-  BEND  
OHNOUT
-  GRIND  
OBROUSIT
-  OPTION  
VOLBA
-  DRILL HOLE  
VRTAT OTVOR
-  REPLACE  
NAHRADIT
-  SYMMETRICAL ASSEMBLY  
SYMETRICKÁ MONTÁŽ
-  SCRIBE THE PANEL AND HOLES  
RYTÍ
-  REVERSE SIDE  
OTOČIT

