

# 648 386 GBU-38 Thermally Protected

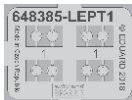

1/48 scale

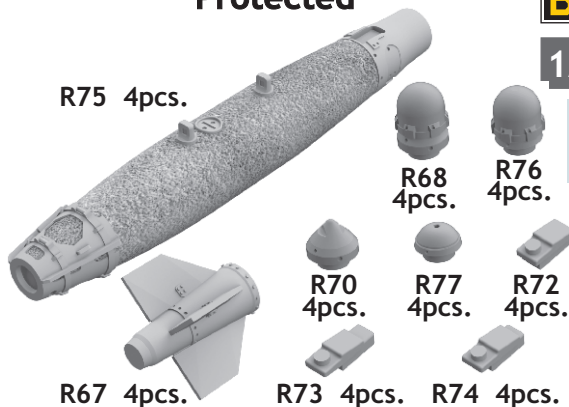

## COLOURS

GSI Creos (GUNZE)		Mr.METAL COLOR	
AQUEOUS	Mr.COLOR	Mr.COLOR	
[H 4]	C 4	MC215	COPPER
[H 8]	C 8		
[H12]	C33		
[H44]	C51		
[H52]	C12		
[H308]	C308		
		Mr.COLOR SUPER METALLIC	
		SM05	SUPER TITANIUM

This product contains metal and resin detail parts for upgrading scale plastic models. When selecting this set make sure that it is for the kit mentioned in product name as these sets are made specifically for that kit. When upgrading the model some cutting or corrections may be necessary for parts to fit accurately. **WARNING!** This set contains small and sharp parts. Work carefully in a ventilated and well-lit room. Safety glasses are recommended. This product is not suitable for children below 14 years of age.

Tento výrobek obsahuje leptané a odlévané detaily pro úpravu a vylepšení plastického modelu. Při výběru sady kovových detailů zkontrolujte, zda je určena pro model, který chcete upravit. Model, pro který je sada určena, je uveden u názvu výrobku. Pro přesnou aplikaci kovových a odlévaných dílů může být zapotřebí upravit díly upravovaného modelu. **POZOR!** Sada obsahuje malé ostré díly. Pracujte ve větrané a dobře osvětlené místnosti. Doporučujeme použití ochranných brýlí. Tento výrobek není vhodný pro děti mladší 14 let.



435 21 Obrnice 170  
Czech Republic

www.eduard.com



# 648 386 GBU-38 Thermally Protected 1/48

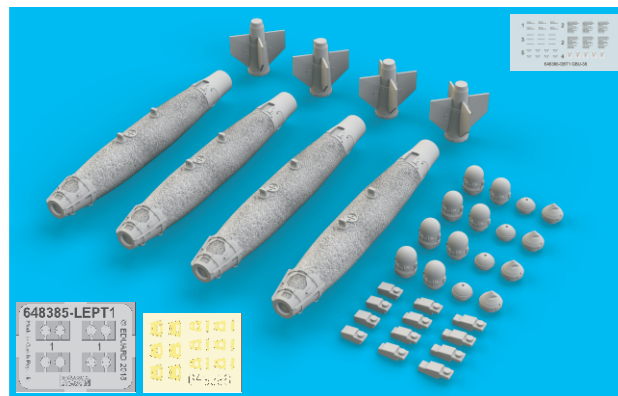
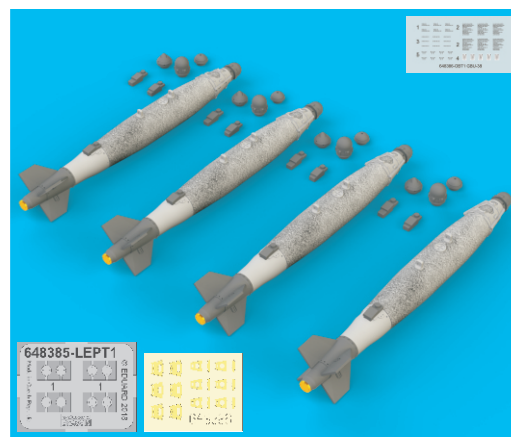

**BEST BRASS RESIN AROUND!**

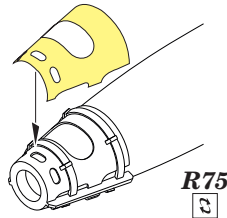
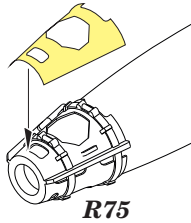
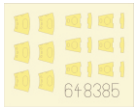

**A** ? **B** ? **C**

**A** GBU-38 USAF

H308 C308 GRAY ? H 52 C 12 OLIVE DRAB



**R72**

H308 C308 GRAY

H 8 C 8 SILVER

SM05 SUPER TITANIUM

**PE01**

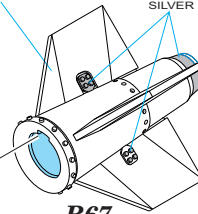

**R67**

H 44 C 51 FLESH

MC215 COPPER

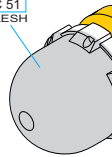

**R68**

H 12 C 33 FLAT BLACK

H 8 C 8 SILVER

H 4 C 4 YELLOW

H 4 C 4 YELLOW

H 8 C 8 SILVER

H308 C308 GRAY ? H 52 C 12 OLIVE DRAB

**R75**

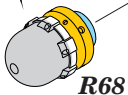

**R68**

**CORRECT POSITION OF TAIL**

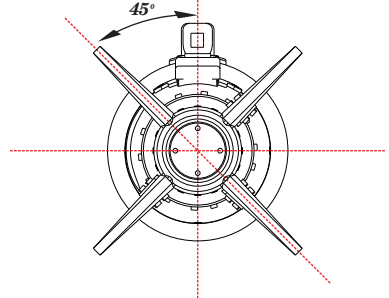

- |                        |                  |  |
|------------------------|------------------|--|
| REMOVE ODSTRANIT       | BEND OHNOUT      | SYMMETRICAL ASSEMBLY SYMETRICKÁ MONTÁŽ |
| GRIND OBROUSIT         | OPTION VOLBA     | SCRIBE THE PANEL AND HOLES RYTÍ        |
| DRILL HOLE VRTÁT OTVOR | REPLACE NAHRADIT | REVERSE SIDE OTOČIT                    |

# B GBU-38 USN

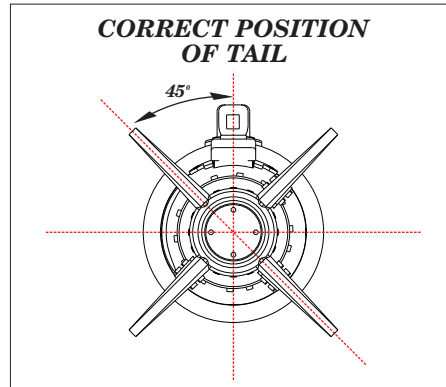
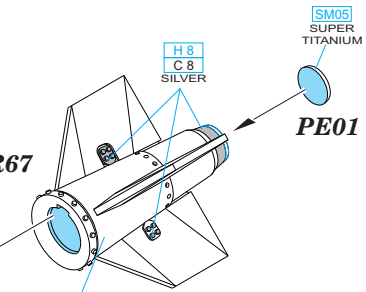
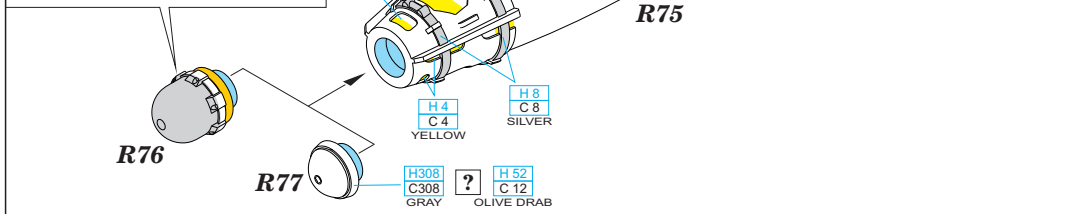
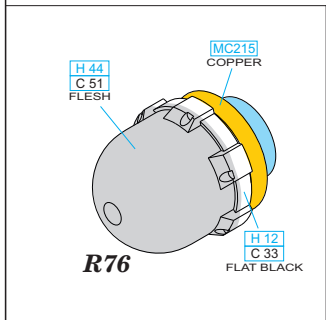



# GBU-38 FOR B-2A

