

648 326 Su-34 wheels

for HOBBY BOSS kit - pro stavebnici HOBBY BOSS

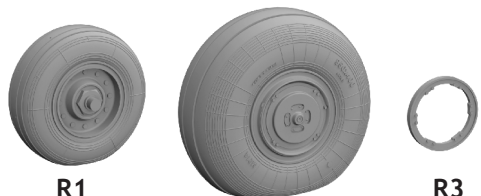

1/48 scale



R1
2pcs.

R2 4pcs.

R3
4pcs.



R4 4pcs.



R5



R6



COLOURS

GSI Creos (GUNZE)		Mr.METAL COLOR	
AQUEOUS	Mr.COLOR	Mr.METAL COLOR	
H26	C66	BRIGHT GREEN	
H57		AIRCRAFT GRAY	MC214 DARK IRON
H77	C137	TIRE BLACK	

This product contains metal and resin detail parts for upgrading scale plastic models. When selecting this set make sure that it is for the kit mentioned in product name as these sets are made specifically for that kit. When upgrading the model some cutting or corrections may be necessary for parts to fit accurately. **WARNING!** This set contains small and sharp parts. Work carefully in a ventilated and well-lit room. Safety glasses are recommended. This product is not suitable for children below 14 years of age.

Tento výrobek obsahuje lepané a odlévané detaily pro úpravu a vylepšení plastického modelu. Při výběru sady kovových detailů zkontrolujte, zda je určena pro model, který chcete upravit. Model, pro který je sada určena, je uveden u názvu výrobku. Pro přesnou aplikaci kovových a odlévaných dílů může být zapotřebí upravit díly upravovaného modelu. **POZOR!** Sada obsahuje malé ostré díly. Pracujte ve větrané a dobře osvětlené místnosti. Doporučujeme použít ochranných brýlí. Tento výrobek není vhodný pro děti mladší 14 let.



435 21 Obrnice 170
Czech Republic

www.eduard.com









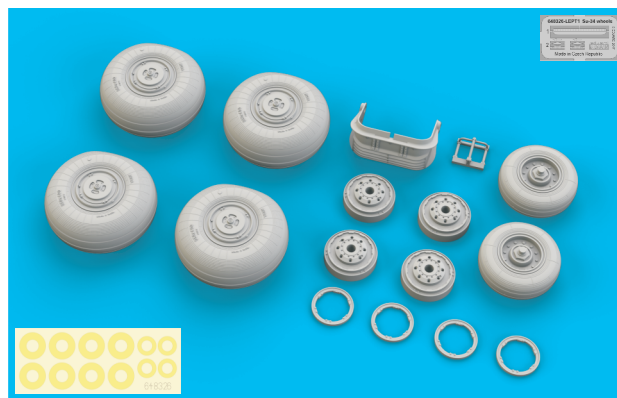
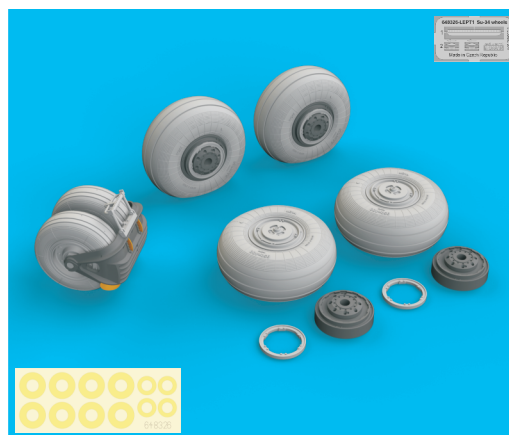

648 326 Su-34 wheels

for HOBBY BOSS kit - pro stavebnici HOBBY BOSS

1/48



BEST BRASS RESIN AROUND!

-  REMOVE
ODSTRANIT
-  BEND
OHNOUT
-  SYMMETRICAL ASSEMBLY
SYMETRICKA MONTAZ
-  GRIND
OBROUSIT
-  OPTION
VOLBA
-  SCRIBE THE PANEL AND HOLES
RYTI
-  DRILL HOLE
VRTAT OTVOR
-  REPLACE
NAHRADIT
-  REVERSE SIDE
OTOČIT

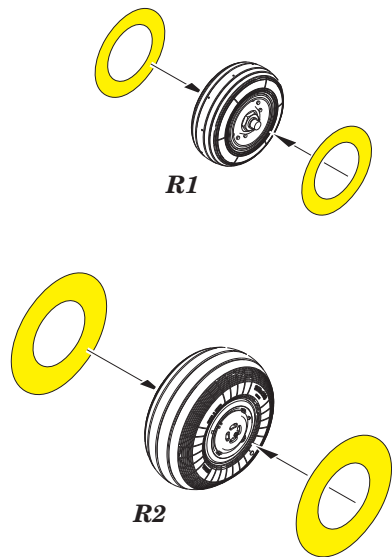
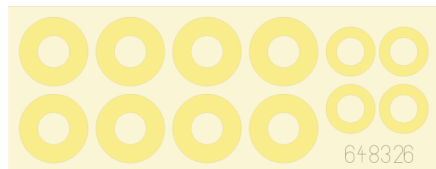

1

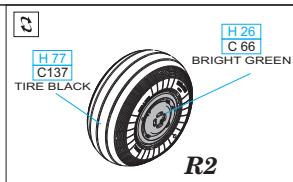
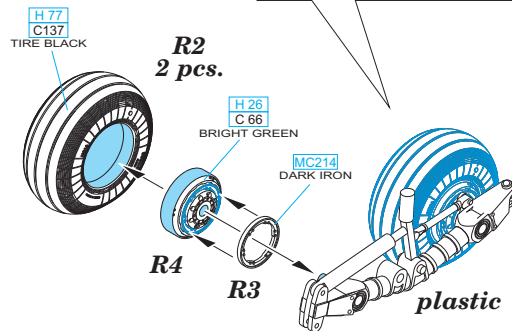

2

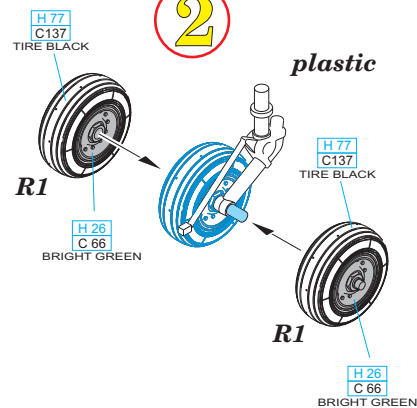

3

