

# 632 087 A6M5c Zero wheels

for Hasegawa kit - pro stavebnici Hasegawa



1/32 scale



R1 2pcs.



R2



R3



R4



## COLOURS

GSI Creos (GUNZE)			Mr.METAL COLOR	
AQUEOUS	Mr.COLOR			
<a href="#">H 8</a>	<a href="#">C 8</a>	SILVER		
<a href="#">H12</a>	<a href="#">C33</a>	FLAT BLACK		
<a href="#">H77</a>	<a href="#">C137</a>	TIRE BLACK		

This product contains metal and resin detail parts for upgrading scale plastic models. When selecting this set make sure that it is for the kit mentioned in product name as these sets are made specifically for that kit. When upgrading the model some cutting or corrections may be necessary for parts to fit accurately. **WARNING!** This set contains small and sharp parts. Work carefully in a ventilated and well-lit room. Safety glasses are recommended. This product is not suitable for children below 14 years of age.

Tento výrobek obsahuje leptané a odlévané detaily pro úpravu a vylepšení plastického modelu. Při výběru sady kovových detailů zkontrolujte, zda je určena pro model, který chcete upravit. Model, pro který je sada určena, je uveden u názvu výrobku. Pro přesnou aplikaci kovových a odlévaných dílů může být zapotřebí upravit díly upravovaného modelu. **POZOR!** Sada obsahuje malé ostré díly. Pracujte ve větrané a dobře osvětlené místnosti. Doporučujeme použití ochranných brýlí. Tento výrobek není vhodný pro děti mladší 14 let.

**eduard**

435 21 Obrnice 170  
Czech Republic



www.eduard.com



# 632 087 A6M5c Zero wheels

for Hasegawa kit - pro stavebnici Hasegawa

1/32

**BRASSIN**



**BRASSIN**

**eduard**



**BEST BRASS RESIN AROUND!**

1

H 77  
C 137  
TIRE BLACK

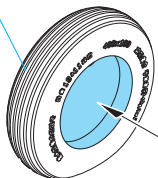

R1

H 8  
C 8  
SILVER



R2 R3

plastic

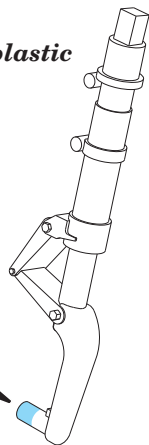

wire  
Ø - 0,6mm  
l - 47mm

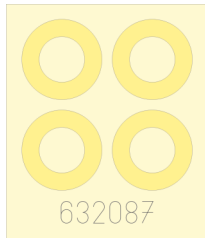
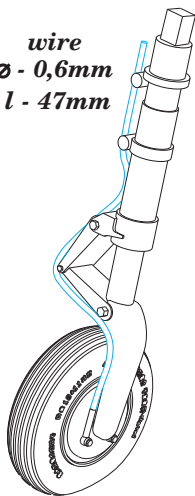

H 8  
C 8  
SILVER

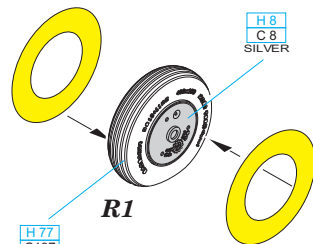

R1

H 77  
C 137  
TIRE BLACK

R2 - right wheel  
R3 - left wheel

4

H 12  
C 33  
FLAT BLACK

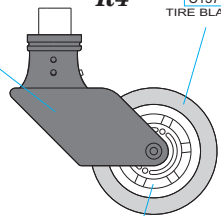

R4

H 77  
C 137  
TIRE BLACK



R4

H 8  
C 8  
SILVER

CORRECT POSITION

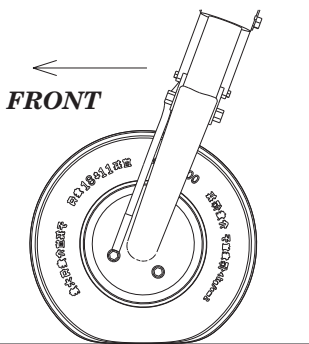

FRONT

2

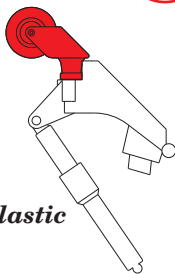

plastic



3

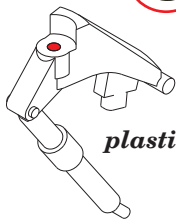

plastic



Ø - 1 mm  
l - 1,2mm

- REMOVE  
ODSTRANIT
- GRIND  
OBROUSIT
- DRILL HOLE  
VRTAT OTVOR
- SYMMETRICAL ASSEMBLY  
SYMETRICKÁ MONTÁŽ
- SCRIBE THE PANEL AND HOLES  
RYTI
- REVERSE SIDE  
OTOČIT
- BEND  
OHNOUT
- OPTION  
VOLBA
- REPLACE  
NAHRADIT