

# 632 046 F-104 undercarriage wheels late

for F-104G/S

for Italeri kit - pro stavebnici Italeri



1/32 scale

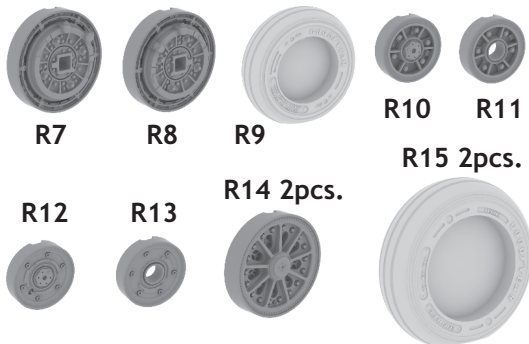
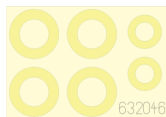

## COLOURS

GSI Creos (GUNZE)		Mr.METAL COLOR	
AQUEOUS	Mr.COLOR	TIRE BLACK	ALUMINIUM
H77	C137		MC218

This product contains metal and resin detail parts for upgrading scale plastic models. When selecting this set make sure that it is for the kit mentioned in product name as these sets are made specifically for that kit. When upgrading the model some cutting or corrections may be necessary for parts to fit accurately. **WARNING!** This set contains small and sharp parts. Work carefully in a ventilated and well-lit room. Safety glasses are recommended. This product is not suitable for children below 14 years of age.

Tento výrobek obsahuje leptané a odlévané detaily pro úpravu a vylepšení plastického modelu. Při výběru sady kovových detailů zkontrolujte, zda je určena pro model, který chcete upravit. Model, pro který je sada určena, je uveden u názvu výrobku. Pro přesnou aplikaci kovových a odlévaných dílů může být zapotřebí upravit díly upravovaného modelu. **POZOR!** Sada obsahuje malé ostré díly. Pracujte ve větrané a dobře osvětlené místnosti. Doporučujeme použití ochranných brýlí. Tento výrobek není vhodný pro děti mladší 14 let.

**eduard**

435 21 Obrnice 170  
Czech Republic

www.eduard.com



# 632 046 F-104 undercarriage wheels late 1/32

for Italeri kit - pro stavebnici Italeri

**BRASSIN**



**BRASSIN**

**eduard**

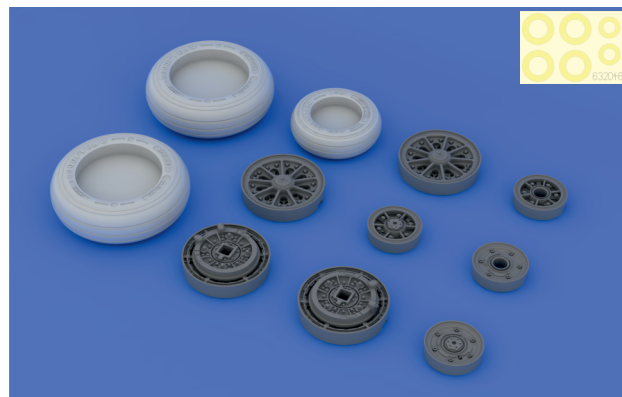

**BEST BRASS RESIN AROUND!**

- |                           |                     |   |
|---------------------------|---------------------|---|
| REMOVE<br>ODSTRANIT       | BEND<br>OHNOUT      | SYMMETRICAL ASSEMBLY<br>SYMETRICKA MONTAZ |
| GRIND<br>OBROUSIT         | ? OPTION<br>VOLBA   | SCRIBE THE PANEL AND HOLES<br>RYTI        |
| DRILL HOLE<br>VRTAT OTVOR | REPLACE<br>NAHRADIT | REVERSE SIDE<br>OTOČIT                    |

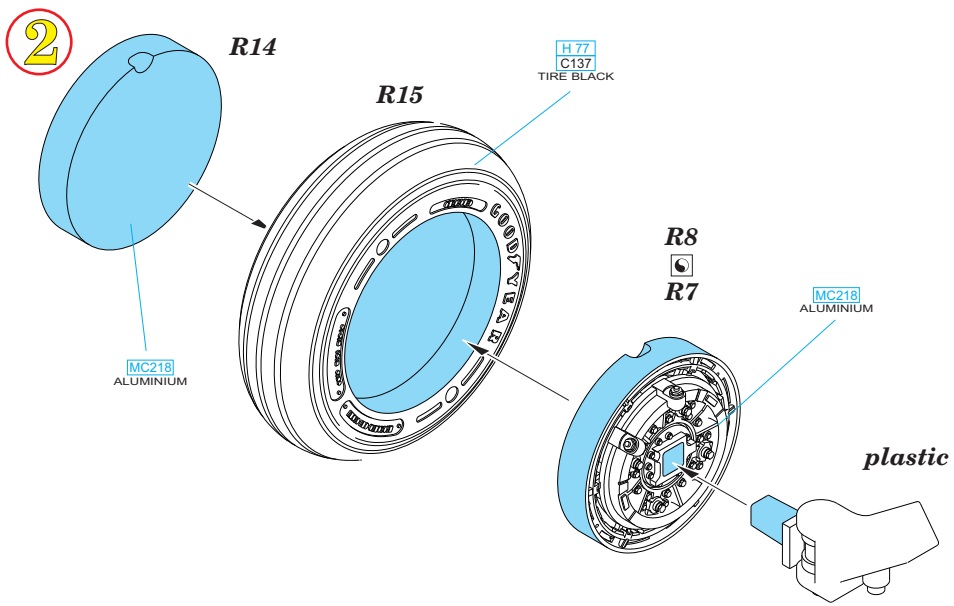
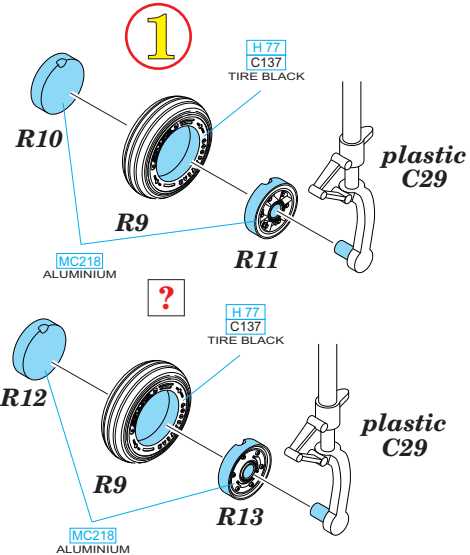

R7 - RIGHT SIDE  
R8 - LEFT SIDE

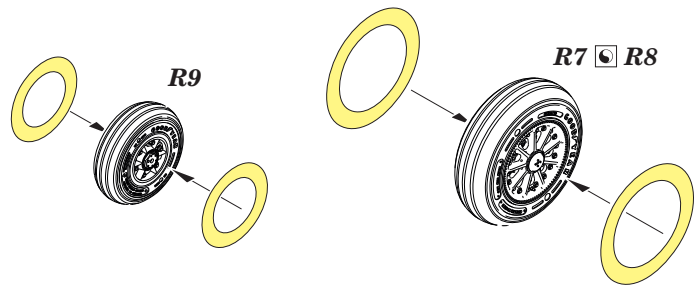
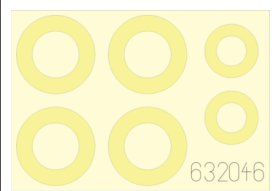

**CORRECT POSITION OF WHEELS**

