

1

★ APPLY EXPRESS MASK AND PAINT BEFORE GLUING  
POUŽIT EXPRESS MASK NABARVIT PŘED SLEPENÍM

☯ SYMMETRICAL ASSEMBLY  
SYMETRICKÁ MONTÁŽ

✂ REMOVE  
ODSTRANIT

🔪 GRIND  
OBROUSIT

🔧 DRILL HOLE  
VRTAT OTVOR

4 3D DECAL PARTS  
3D OBTISKY

1 COLORED ETCHED PARTS  
LEPTANÉ BAREVNÉ DÍLY

1 ETCHED PARTS  
LEPTANÉ NEBAREVNÉ DÍLY

1 ORIGINAL KIT PARTS  
PŮVODNÍ DÍLY STAVEBNICE

↪ BEND  
OHNOUT

❓ OPTION  
VOLBA

Ⓜ REPLACE  
NAHRADIT

■ ORIGINAL KIT PARTS  
PŮVODNÍ DÍLY STAVEBNICE

■ COLORED 3D DECAL PARTS  
BAREVNÉ 3D OBTISKY

■ PHOTO-ETCHED PARTS  
LEPTANÉ DÍLY

■ PARTS TO BE REMOVED  
DÍLY K ODSTRANĚNÍ

■ FILL  
TMELIT

3DL48177

P-51B/C

1/48

detail set for 1/48 EDUARD kit • sada detailů pro stavebnici 1/48 EDUARD

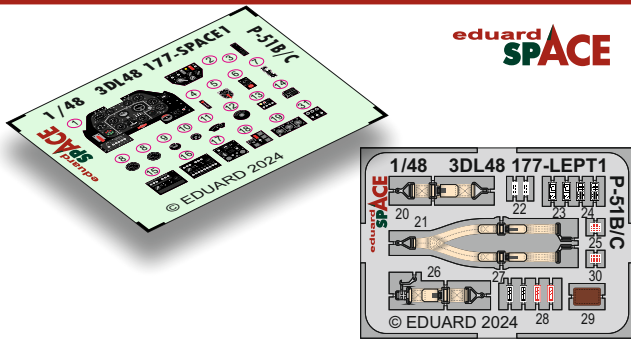

2

## 3D decals

• Soak the decal in the warm water for couple of seconds and after its separation from the backing paper position it on the model.

• To increase decal's adherence use the white glue, Mr. Mark Setter or apply to the glossy surface.

• Leaving decal in the water for too long can cause its swelling and distortion.

## PE parts

• Use cyanoacrylate glue to attach.

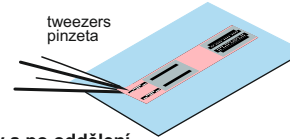

## 3D decals

• Vložte na několik vteřin do teplé vody a po oddělení od podkladového papíru naneste na model.

• Pro zvýšení přilnavosti lze použít disperzní lepidlo, Mr. Mark Setter či obtisk nanášet na lesklý povrch.

• Příliš dlouhé vystavení 3D obtisku vodě může způsobit jeho nabobtnání.

## PE parts

• K lepení použijte kyanoakrylátové lepidlo.

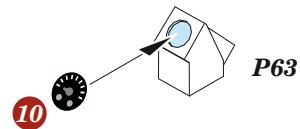
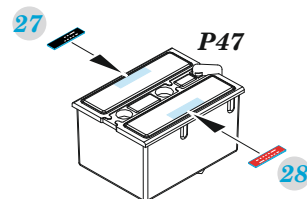
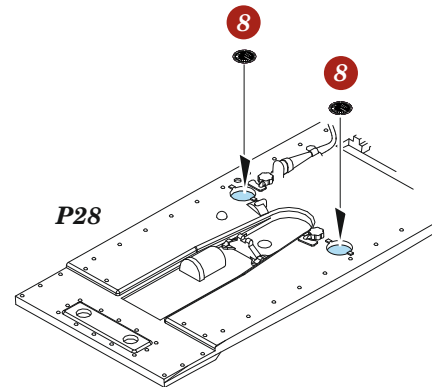

3

P27 ? P33

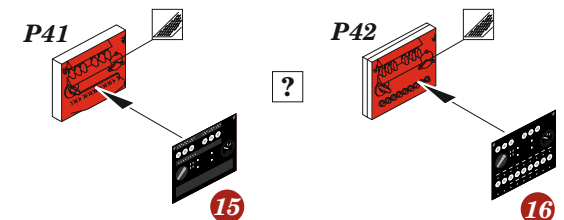
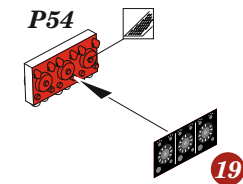
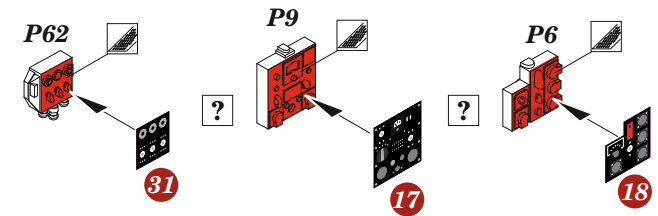
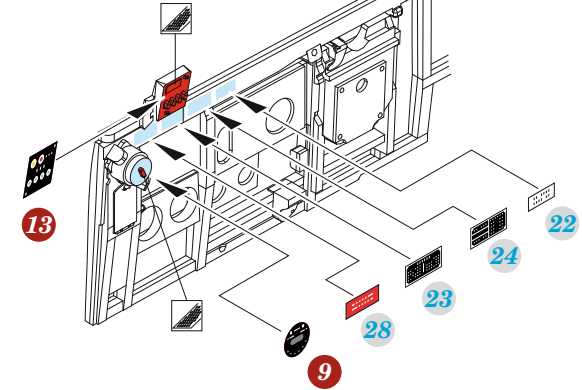

**A**

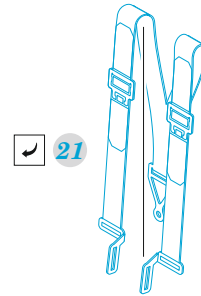
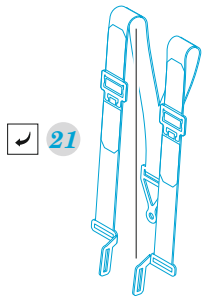
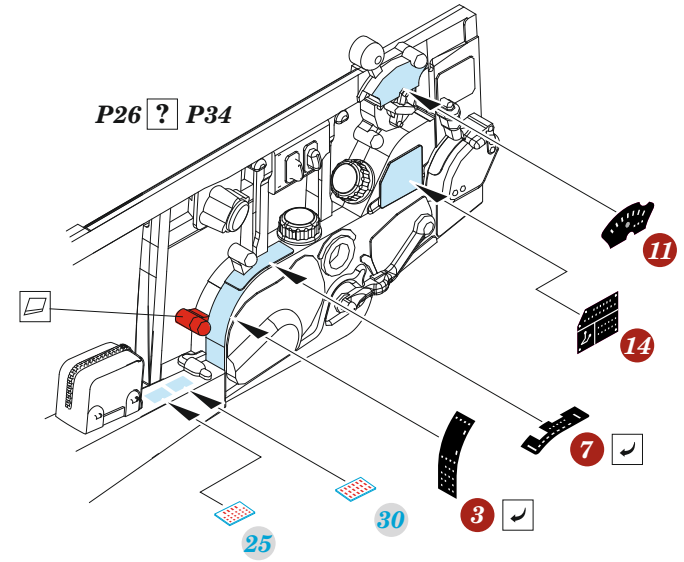
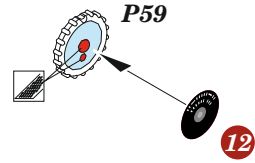
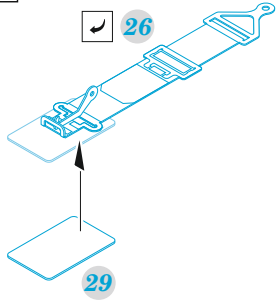

**?**

